







COLLEZIONE

# EASY

---

PRISMA-CLEAN LAVELLI  
DAL BORDO PRISMATICO



COLLEZIONE

# EASY

Un progetto essenziale, unico, senza tempo. Un prodotto unico dallo spiccato carattere innovativo che armonizza una funzionalità estrema con la capacità di poter “modellarsi” alle esigenze di chi lo utilizza fino a poter “scomparere” del tutto.



SOPRATOP



Lavello Easy 300 G68 Bianco con miscelatore Bridge Cromato

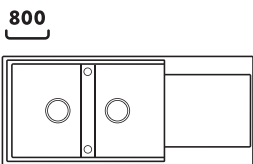

**EASY 500**  
PAG. 144

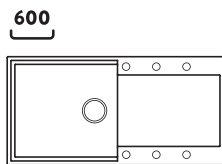

**EASY 480**  
PAG. 144

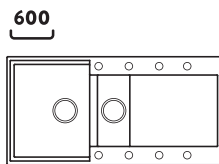

**EASY 475**  
PAG. 145

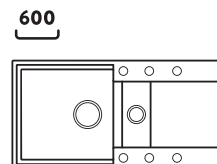

**EASY 425**  
PAG. 145

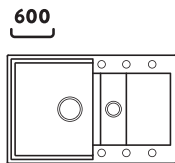

**EASY 325**  
PAG. 146

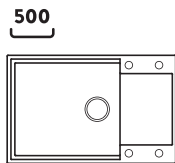

**EASY 310**  
PAG. 146

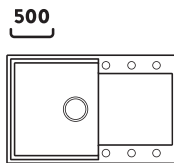

**EASY 300**  
PAG. 147

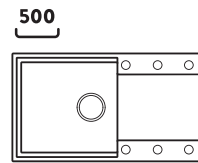

**EASY 290**  
PAG. 147

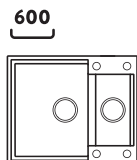

**EASY 150**  
PAG. 148

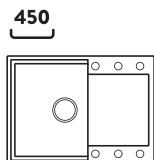

**EASY 135**  
PAG. 148

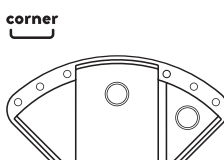

**EASY CORNER**  
PAG. 149

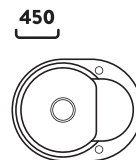

**EASY ROUND 600**  
PAG. 149

**Corredo del lavello:** Sifone salvaspazio, pilette e ganci.

**GRANITEK**  
NATURAL GRANITE EFFECT



**M79** Aluminium



**M78** Espresso



**M73** Titanium



**M70** Ghisa

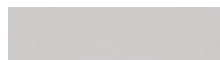

**G68** Bianco



**G48** Cemento



**G43** Tortora



**G40** Nero

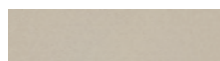

**G62** Bianco antico



**G59** Antracite



**G51** Avena



DISEGNI TECNICI  
APPROFONDITI  
LINEA EASY



**VASCA XL**

Vasca dallo spazio ampio e maggiorato per ospitare utensili di grandi dimensioni e facilitare le operazioni di utilizzo.

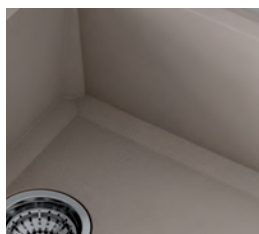

**PRISMA CLEAN**

Il sistema Prisma-clean sostituisce le classiche raggiature interne con facce prismatiche che ammorbidiscono e facilitano la pulizia delle aree interne della vasca, mantenendo un deciso carattere estetico.



**DESIGN ESSENZIALE**

Essenzialità e semplicità sono le parole chiave per descrivere il design di Easy, dove il gocciolatoio si caratterizza per le sue linee rette e ben definite.

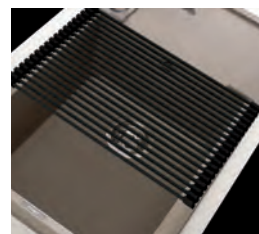

**ACCESSORI ELEMENT**

Tagliere, rollmat e pop up permettono di completare il lavello a proprio gusto e piacimento, rendendo le operazioni di preparazione del cibo più facili e pratiche.



# EASY 500



## Lavello 2 vasche con gocciolatoio

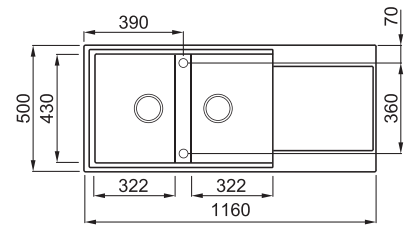

Disegno Tecnico approfondito: QR code a pag. 143



### CARATTERISTICHE

Dimensioni (mm)	<b>1160 x 500</b>
Base (mm)	<b>800</b>
Foro da incasso (mm)	<b>1140 x 480</b>
Profondità Vasca 1 (mm)	<b>200</b>
Profondità Vasca 2 (mm)	<b>200</b>
Orientamento	<b>Reversibile</b>

### MATERIALI E COLORI

**GRANITEK** NATURAL GRANITE EFFECT Euro **400**

#### METAL

● M79 Aluminium	LMY50079
● M78 Espresso	LMY50078
● M73 Titanium	LMY50073
● M70 Ghisa	LMY50070

**GRANITEK** NATURAL GRANITE EFFECT Euro **381**

#### MATT

● G68 Bianco	LGY50068
● G48 Cemento	LGY50048
● G43 Tortora	LGY50043
● G40 Nero	LGY50040

#### CLASSIC

● G62 Bianco Antico	LGY50062
● G59 Antracite	LGY50059
● G51 Avena	LGY50051

### ACCESSORI CONSIGLIATI



# EASY 480

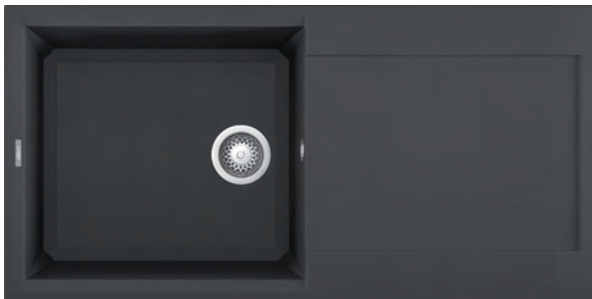

## Lavello 1 vasca con gocciolatoio

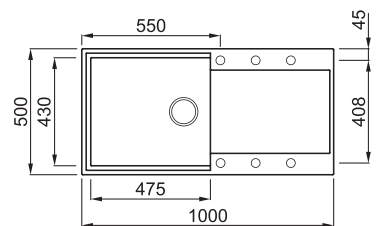

Disegno Tecnico approfondito: QR code a pag. 143



### CARATTERISTICHE

Dimensioni (mm)	<b>1000 x 500</b>
Base (mm)	<b>600</b>
Foro da incasso (mm)	<b>980 x 480</b>
Profondità Vasca (mm)	<b>200</b>
Orientamento	<b>Reversibile</b>

### MATERIALI E COLORI

**GRANITEK** NATURAL GRANITE EFFECT Euro **368**

#### METAL

● M79 Aluminium	LMY48079
● M78 Espresso	LMY48078
● M73 Titanium	LMY48073
● M70 Ghisa	LMY48070

**GRANITEK** NATURAL GRANITE EFFECT Euro **350**

#### MATT

● G68 Bianco	LGY48068
● G48 Cemento	LGY48048
● G43 Tortora	LGY48043
● G40 Nero	LGY48040

#### CLASSIC

● G62 Bianco Antico	LGY48062
● G59 Antracite	LGY48059
● G51 Avena	LGY48051

### ACCESSORI CONSIGLIATI

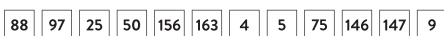

**88** Element Tagliere Sliding 50cm



ATH010OL  
Euro **136**  
Pag. 176

Escluso Easy 425

**156** Element Rollmat 500 - 400

**157**

Euro  
ARS023BK **82**  
ARS013BK **74**  
Pag. 181-182

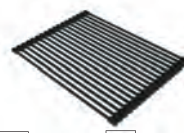

**156**

**157**

Escluso E425 E425

**163** Element Cover Piletta Materica



AKCP1296  
Euro **38**  
Pag. 182



# EASY 475



## CARATTERISTICHE

Dimensioni (mm)	<b>1000 x 500</b>
Base (mm)	<b>600</b>
- se inizio composizione	<b>800</b>
Foro da incasso (mm)	<b>980 x 480</b>
Profondità Vasca 1 (mm)	<b>200</b>
Profondità Vasca 2 (mm)	<b>140</b>
Orientamento	<b>Reversibile</b>

## ACCESSORI CONSIGLIATI

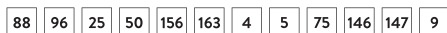

## Lavello 1 vasca ½ con gocciolatoio

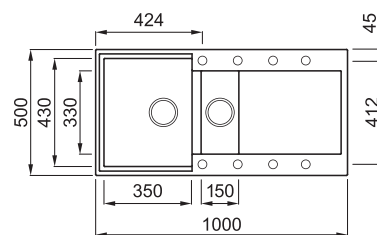

Disegno Tecnico approfondito: QR code a pag. 143

## MATERIALI E COLORI



### METAL

● M79 Aluminium	LMY47579	Euro <b>398</b>
● M78 Espresso	LMY47578	
● M73 Titanium	LMY47573	
● M70 Ghisa	LMY47570	



### MATT

● G68 Bianco	LGY47568	Euro <b>379</b>
● G48 Cemento	LGY47548	
● G43 Tortora	LGY47543	
● G40 Nero	LGY47540	

### CLASSIC

● G62 Bianco Antico	LGY47562
● G59 Antracite	LGY47559
● G51 Avena	LGY47551

# EASY 425



## CARATTERISTICHE

Dimensioni (mm)	<b>860 x 435</b>
Base (mm)	<b>600</b>
Foro da incasso (mm)	<b>840 x 415</b>
Profondità Vasca 1 (mm)	<b>210</b>
Profondità Vasca 2 (mm)	<b>120</b>
Orientamento	<b>Reversibile</b>

## ACCESSORI CONSIGLIATI

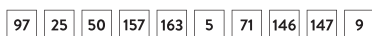

## Lavello 1 vasca ½ con gocciolatoio

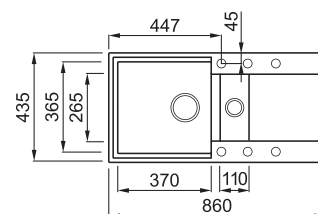

Disegno Tecnico approfondito: QR code a pag. 143

## MATERIALI E COLORI



### METAL

● M79 Aluminium	LMY42579	Euro <b>318</b>
● M78 Espresso	LMY42578	
● M73 Titanium	LMY42573	
● M70 Ghisa	LMY42570	



### MATT

● G68 Bianco	LGY42568	Euro <b>304</b>
● G48 Cemento	LGY42548	
● G43 Tortora	LGY42543	
● G40 Nero	LGY42540	

### CLASSIC

● G62 Bianco Antico	LGY42562
● G59 Antracite	LGY42559
● G51 Avena	LGY42551

97 Element Pop-Up Push Control 2 Vie



ASP23002BK  
Euro **35**  
Pag. 189

5 Colander

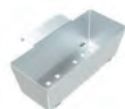

AVI03001  
Euro **116**  
Pag. 186

150 Crema Smacchiante Deep Clean Lavelli Keratek



DLC01602  
Pag. 183



# EASY 325



Lavello 1 vasca 1/2 con gocciolatoio

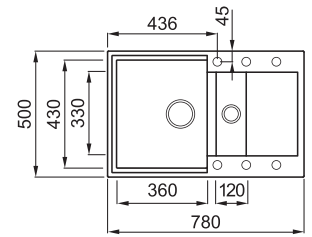

Disegno Tecnico approfondito: QR code a pag. 143



## CARATTERISTICHE

Dimensioni (mm)	<b>780 x 500</b>
Base (mm)	<b>600</b>
Foro da incasso (mm)	<b>760 x 480</b>
Profondità Vasca 1 (mm)	<b>220</b>
Profondità Vasca 2 (mm)	<b>120</b>
Orientamento	<b>Reversibile</b>

## MATERIALI E COLORI

**GRANITEK** NATURAL GRANITE EFFECT Euro **318**

### METAL

● M79 Aluminium	LMY32579
● M78 Espresso	LMY32578
● M73 Titanium	LMY32573
● M70 Ghisa	LMY32570

**GRANITEK** NATURAL GRANITE EFFECT Euro **304**

### MATT

● G68 Bianco	LGY32568
● G48 Cemento	LGY32548
● G43 Tortora	LGY32543
● G40 Nero	LGY32540

### CLASSIC

● G62 Bianco Antico	LGY32562
● G59 Antracite	LGY32559
● G51 Avena	LGY32551

## ACCESSORI CONSIGLIATI

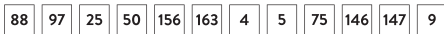

# EASY 310



Lavello 1 vasca con gocciolatoio

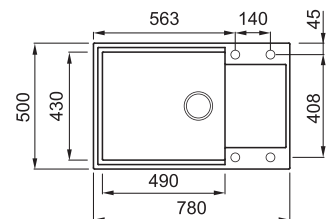

Disegno Tecnico approfondito: QR code a pag. 143



## CARATTERISTICHE

Dimensioni (mm)	<b>780 x 500</b>
Base (mm)	<b>600</b>
- se inizio composizione	<b>800</b>
Foro da incasso (mm)	<b>760 x 480</b>
Profondità Vasca (mm)	<b>200</b>
Orientamento	<b>Reversibile</b>

## MATERIALI E COLORI

**GRANITEK** NATURAL GRANITE EFFECT Euro **314**

### METAL

● M79 Aluminium	LMY31079
● M78 Espresso	LMY31078
● M73 Titanium	LMY31073
● M70 Ghisa	LMY31070

**GRANITEK** NATURAL GRANITE EFFECT Euro **299**

### MATT

● G68 Bianco	LGY31068
● G48 Cemento	LGY31048
● G43 Tortora	LGY31043
● G40 Nero	LGY31040

### CLASSIC

● G62 Bianco Antico	LGY31062
● G59 Antracite	LGY31059
● G51 Avena	LGY31051

## ACCESSORI CONSIGLIATI



88 Element Tagliere Sliding 50cm



ATH0100L  
Euro **136**  
Pag. 176

Escluso Easy 290

156 Element Rollmat 500 - 400

157

ARS023BK Euro **82**  
ARS013BK Euro **74**  
Pag. 181-182

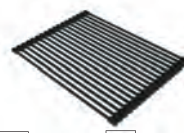

156

157

Escluso E290 E290

146 Cover piletta



ACPM1000  
Euro **19**  
Pag. 187



# EASY 300



## CARATTERISTICHE

Dimensioni (mm)	<b>790 x 500</b>
Base (mm)	<b>500</b>
- se inizio composizione	<b>600</b>
Foro da incasso (mm)	<b>770 x 480</b>
Profondità Vasca (mm)	<b>220</b>
Orientamento	<b>Reversibile</b>

## ACCESSORI CONSIGLIATI



## Lavello 1 vasca con gocciolatoio

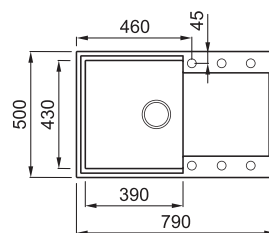

Disegno Tecnico approfondito: QR code a pag. 143

## MATERIALI E COLORI

**GRANITEK**  
NATURAL GRANITE EFFECT

Euro **303**

### METAL

● M79 Aluminium	LMY30079
● M78 Espresso	LMY30078
● M73 Titanium	LMY30073
● M70 Ghisa	LMY30070

**GRANITEK**  
NATURAL GRANITE EFFECT

Euro **288**

### MATT

● G68 Bianco	LGY30068
● G48 Cemento	LGY30048
● G43 Tortora	LGY30043
● G40 Nero	LGY30040

### CLASSIC

● G62 Bianco Antico	LGY30062
● G59 Antracite	LGY30059
● G51 Avena	LGY30051

# EASY 290



## CARATTERISTICHE

Dimensioni (mm)	<b>780 x 435</b>
Base (mm)	<b>500</b>
- se inizio composizione	<b>600</b>
Foro da incasso (mm)	<b>760 x 415</b>
Profondità Vasca (mm)	<b>210</b>
Orientamento	<b>Reversibile</b>

## ACCESSORI CONSIGLIATI



## Lavello 1 vasca con gocciolatoio

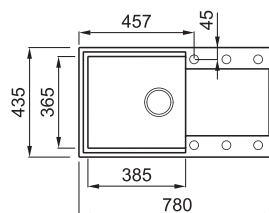

Disegno Tecnico approfondito: QR code a pag. 143

## MATERIALI E COLORI

**GRANITEK**  
NATURAL GRANITE EFFECT

Euro **303**

### METAL

● M79 Aluminium	LMY29079
● M78 Espresso	LMY29078
● M73 Titanium	LMY29073
● M70 Ghisa	LMY29070

**GRANITEK**  
NATURAL GRANITE EFFECT

Euro **288**

### MATT

● G68 Bianco	LGY29068
● G48 Cemento	LGY29048
● G43 Tortora	LGY29043
● G40 Nero	LGY29040

### CLASSIC

● G62 Bianco Antico	LGY29062
● G59 Antracite	LGY29059
● G51 Avena	LGY29051

25 Element Dispenser  
Sapone Tondo



ADI02300  
Euro **38**  
Pag. 180

75 Cestello



ACI01307  
Euro **93**  
Pag. 186

Escluso Easy 290

160 Spray Detergente  
Sgrassante Daily Clean



DLL01601  
Pag. 183

# EASY 150

Lavello 1 vasca 1/2

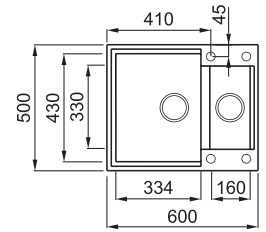

Disegno Tecnico approfondito: QR code a pag. 143

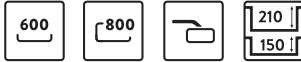

## CARATTERISTICHE

Dimensioni (mm)	<b>600 x 500</b>
Base (mm)	<b>600</b>
- se inizio composizione	<b>800</b>
Foro da incasso (mm)	<b>580 x 480</b>
Profondità Vasca 1 (mm)	<b>210</b>
Profondità Vasca 2 (mm)	<b>150</b>
Orientamento	<b>Reversibile</b>

## ACCESSORI CONSIGLIATI

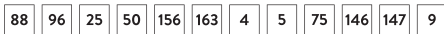

## MATERIALI E COLORI

**GRANITEK** NATURAL GRANITE EFFECT Euro **293**

### METAL

● M79 Aluminium	LMY15079
● M78 Espresso	LMY15078
● M73 Titanium	LMY15073
● M70 Ghisa	LMY15070

**GRANITEK** NATURAL GRANITE EFFECT Euro **278**

### MATT

● G68 Bianco	LGY15068
● G48 Cemento	LGY15048
● G43 Tortora	LGY15043
● G40 Nero	LGY15040

### CLASSIC

● G62 Bianco Antico	LGY15062
● G59 Antracite	LGY15059
● G51 Avena	LGY15051

# EASY 135

Lavello 1 vasca con gocciolatoio

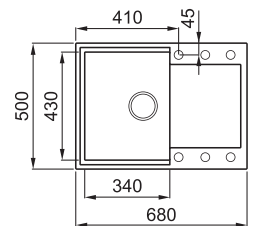
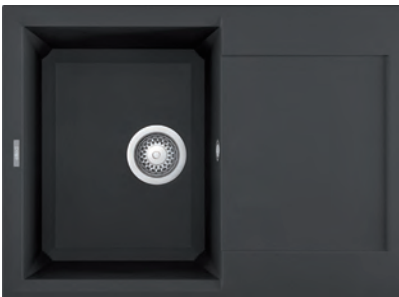

Disegno Tecnico approfondito: QR code a pag. 143



## CARATTERISTICHE

Dimensioni (mm)	<b>680 x 500</b>
Base (mm)	<b>450</b>
- se inizio composizione	<b>600</b>
Foro da incasso (mm)	<b>660 x 480</b>
Profondità Vasca (mm)	<b>210</b>
Orientamento	<b>Reversibile</b>

## ACCESSORI CONSIGLIATI



## MATERIALI E COLORI

**GRANITEK** NATURAL GRANITE EFFECT Euro **260**

### METAL

● M79 Aluminium	LMY13579
● M78 Espresso	LMY13578
● M73 Titanium	LMY13573
● M70 Ghisa	LMY13570

**GRANITEK** NATURAL GRANITE EFFECT Euro **247**

### MATT

● G68 Bianco	LGY13568
● G48 Cemento	LGY13548
● G43 Tortora	LGY13543
● G40 Nero	LGY13540

### CLASSIC

● G62 Bianco Antico	LGY13562
● G59 Antracite	LGY13559
● G51 Avena	LGY13551

88 Element Tagliere Sliding 50cm



ATH010QU  
Euro **136**  
Pag. 176

156 Element Rollmat 500

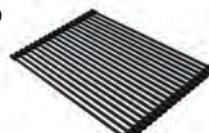

ARS023BK  
Euro **82**  
Pag. 181

Solo Easy 150

163 Element Cover Piletta Materica



AKCP1295  
Euro **38**  
Pag. 182



# EASY CORNER



## CARATTERISTICHE

Dimensioni (mm)	<b>1057 x 575</b>
Base (mm)	<b>Angolare</b>
- Top minimo 650 mm	<b>800</b>
Foro da incasso (mm)	<b>da disegno</b>
Profondità Vasca 1 (mm)	<b>210</b>
Profondità Vasca 2 (mm)	<b>150</b>
Orientamento	<b>Non reversibile</b>

## ACCESSORI CONSIGLIATI

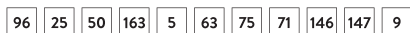

# EASY ROUND 600



## CARATTERISTICHE

Dimensioni (mm)	<b>600 x 470</b>
Base (mm)	<b>450</b>
Foro da incasso (mm)	<b>da disegno</b>
Profondità Vasca (mm)	<b>200</b>
Orientamento	<b>Reversibile</b>

## ACCESSORI CONSIGLIATI

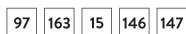

15 Cestello Round

ACI02301  
Euro **65**  
Pag. 186



63 Colander Easy Corner

AVI03307  
Euro **108**  
Pag. 186



Solo Easy Corner

Levello angolare 1 vasca ½ con gocciolatoio

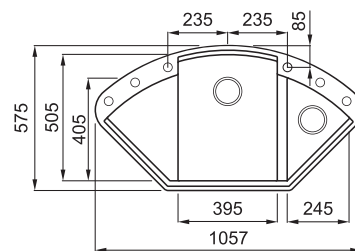

Disegno Tecnico approfondito: QR code a pag. 143

## MATERIALI E COLORI

**GRANITEK**  
NATURAL GRANITE EFFECT

Euro **420**

### METAL

- M79 Aluminium LMYCOR79
- M78 Espresso LMYCOR78
- M73 Titanium LMYCOR73
- M70 Ghisa LMYCOR70

### ACCESSORIO CONSIGLIATO COLANDER EASY CORNER

AVI03307 Euro **108**



**GRANITEK**  
NATURAL GRANITE EFFECT

Euro **402**

### MATT

- G68 Bianco LGYCOR68
- G48 Cemento LGYCOR48
- G43 Tortora LGYCOR43
- G40 Nero LGYCOR40

### CLASSIC

- G62 Bianco Antico LGYCOR62
- G59 Antracite LGYCOR59
- G51 Avena LGYCOR51

Levello 1 vasca con gocciolatoio

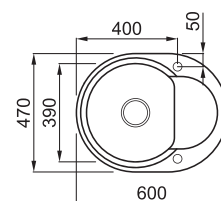

Disegno Tecnico approfondito: QR code a pag. 143

## MATERIALI E COLORI

**GRANITEK**  
NATURAL GRANITE EFFECT

Euro **249**

### METAL

- M79 Aluminium LMYR6079
- M78 Espresso LMYR6078
- M73 Titanium LMYR6073
- M70 Ghisa LMYR6070

**GRANITEK**  
NATURAL GRANITE EFFECT

Euro **237**

### MATT

- G68 Bianco LGYR6068
- G48 Cemento LGYR6048
- G43 Tortora LGYR6043
- G40 Nero LGYR6040

### CLASSIC

- G62 Bianco Antico LGYR6062
- G59 Antracite LGYR6059
- G51 Avena LGYR6051

158 Spray Anticalcare  
Disincrostante Daily Clean

DLA01601  
Pag. 184









COLLEZIONE

# FOX

MODELLI PER SPAZI VERSATILI



COLLEZIONE

# FOX

Una collezione di lavelli molto versatile.

Si adatta perfettamente ad ogni tipologia di spazio a disposizione sul top da cucina.

Ogni modello è combinabile con numerosi accessori e molteplici colorazioni.



SOPRATOP



Lavello Fox 450 G59 Antracite con miscelatore Neva Inox



900

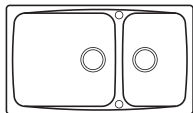

**FOX 450**  
PAG. 154

900

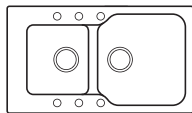

**FOX 430**  
PAG. 154

900

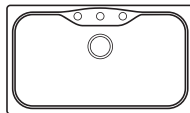

**FOX 360**  
PAG. 155

800

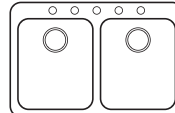

**FOX 340**  
PAG. 155

800

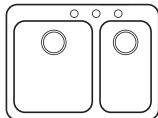

**FOX 330**  
PAG. 156

600

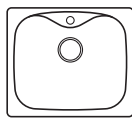

**FOX 200**  
PAG. 156

600

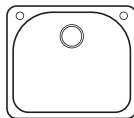

**FOX 180**  
PAG. 157

450



**FOX ROUND**  
PAG. 157



DISEGNI TECNICI  
APPROFONDITI  
LINEA FOX

**Corredo del lavello:** Sifone salvaspazio, pilette e ganci.

**GRANITEK**  
NATURAL GRANITE EFFECT

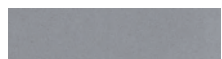

**M79** Aluminium

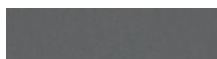

**M73** Titanium

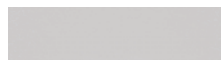

**G68** Bianco



**G40** Nero

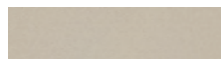

**G62** Bianco Antico



**G59** Antracite



**G55** Grigio Pietra



**G54** Nero Pietra



**G52** Bianco Pietra



**G51** Avena



**VASCA CON ANGOLI  
ARROTONDATI**

Caratterizzata dagli angoli interni arrotondati delle vasche, la collezione Fox è particolarmente indicata per ambienti cucina classici.



**ACCESSORI ELEMENT**

Tagliere, rollmat e pop up permettono di completare il lavello a proprio gusto e piacimento, rendendo le operazioni di preparazione del cibo più facili e pratiche.



**ACCESSORIO KIT  
PILETTA OTTONATA**

L'accessorio piletta ottonata conferisce al lavello una sensazione di matericità tattile, nobilitando gli arredi e diventando protagonista di nuove sperimentazioni cromatiche.

## FOX 450



Lavello 2 vasche

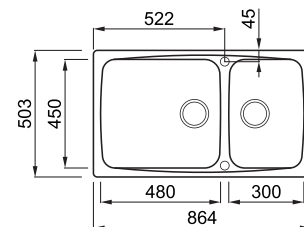

Disegno Tecnico approfondito: QR code a pag. 153



### CARATTERISTICHE

Dimensioni (mm)	<b>864 x 503</b>
Base (mm)	<b>900</b>
Foro da incasso (mm)	<b>840 x 490</b>
Profondità Vasca 1 (mm)	<b>225</b>
Profondità Vasca 2 (mm)	<b>225</b>
Orientamento	<b>Reversibile</b>

### MATERIALI E COLORI

**GRANITEK**  
NATURAL GRANITE EFFECT

Euro **362**

#### MATT

- G68 Bianco LGF45068
- G40 Nero LGF45040

#### CLASSIC

- G62 Bianco Antico LGF45062
- G59 Antracite LGF45059
- G51 Avena LGF45051

### ACCESSORI CONSIGLIATI



## FOX 430



Lavello 2 vasche

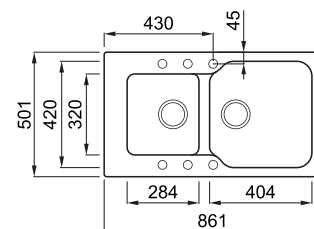

Disegno Tecnico approfondito: QR code a pag. 153



### CARATTERISTICHE

Dimensioni (mm)	<b>861 x 501</b>
Base (mm)	<b>900</b>
Foro da incasso (mm)	<b>840 x 490</b>
Profondità Vasca 1 (mm)	<b>200</b>
Profondità Vasca 2 (mm)	<b>200</b>
Orientamento	<b>Reversibile</b>

### MATERIALI E COLORI

**GRANITEK**  
NATURAL GRANITE EFFECT

Euro **362**

#### MATT

- G68 Bianco LGF43068
- G40 Nero LGF43040

#### CLASSIC

- G62 Bianco Antico LGF43062
- G59 Antracite LGF43059
- G51 Avena LGF43051

### ACCESSORI CONSIGLIATI

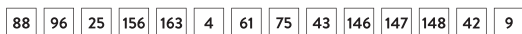

**88** Element Tagliere Sliding 50cm



ATH010OL  
Euro **136**  
Pag. 176

Esclusi Fox 360/340

**156** Element Rollmat 500



ARS023BK  
Euro **82**  
Pag. 181

**148** Kit Piletta 2 vie e troppopieno ottonati



APM2VSCTPGO  
Euro **114**  
Pag. 187

# FOX 360



Lavello 1 vasca

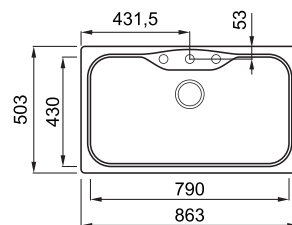

## MATERIALI E COLORI

**GRANITEK**  
NATURAL GRANITE EFFECT

Euro **384**

METAL

- M79 Aluminium LMF36079
- M73 Titanium LMF36073

**GRANITEK**  
NATURAL GRANITE EFFECT

Euro **366**

MATT

- G68 Bianco LGF36068
- G40 Nero LGF36040

## CARATTERISTICHE

Dimensioni (mm)	<b>863 x 503</b>
Base (mm)	<b>900</b>
Foro da incasso (mm)	<b>840 x 490</b>
Profondità Vasca (mm)	<b>225</b>
Orientamento	<b>Non reversibile</b>

Disegno Tecnico approfondito: QR code a pag. 153

## ACCESSORIO CONSIGLIATO

### ELEMENT TAGLIERE FOX 360

- Olmo ATH130OL Euro **165**



## CLASSIC

- G62 Bianco Antico LGF36062
- G59 Antracite LGF36059
- G55 Grigio Pietra LGF36055
- G54 Nero Pietra LGF36054
- G52 Bianco Pietra LGF36052
- G51 Avena LGF36051

## ACCESSORI CONSIGLIATI



# FOX 340



Lavello 2 vasche

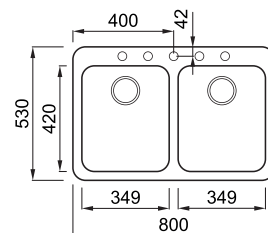

## MATERIALI E COLORI

**GRANITEK**  
NATURAL GRANITE EFFECT

Euro **350**

MATT

- G68 Bianco LGF34068BTP
- G40 Nero LGF34040BTP

## CARATTERISTICHE

Dimensioni (mm)	<b>800 x 530</b>
Base (mm)	<b>800</b>
Foro da incasso (mm)	<b>780 x 520 R32</b>
Profondità Vasca 1 (mm)	<b>220</b>
Profondità Vasca 2 (mm)	<b>220</b>
Orientamento	<b>Non reversibile</b>

Disegno Tecnico approfondito: QR code a pag. 153

## CLASSIC

- G62 Bianco Antico LGF34062BTP
- G59 Antracite LGF34059BTP
- G51 Avena LGF34051BTP

## ACCESSORI CONSIGLIATI

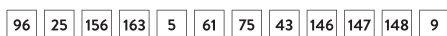

155 Element Tagliere  
Fox 360



ATH130OL  
Euro **165**  
Pag. 176

96 Element Pop-Up  
Push Control 2 vie



ASP23002  
Euro **66**  
Pag. 179

162 Panni in Microfibra  
Fast Clean

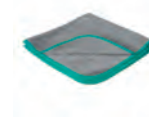

AMP01001  
Pag. 185



## FOX 330



Lavello 2 vasche

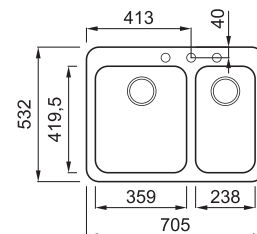

### CARATTERISTICHE

Dimensioni (mm)	<b>705 x 532</b>
Base (mm)	<b>800</b>
Foro da incasso (mm)	<b>680 x 520 R32</b>
Profondità Vasca 1 (mm)	<b>230</b>
Profondità Vasca 2 (mm)	<b>200</b>
Orientamento	<b>Non reversibile</b>

Disegno Tecnico approfondito: QR code a pag. 153

### MATERIALI E COLORI

**GRANITEK**  
NATURAL GRANITE EFFECT

Euro **333**

#### MATT

- G68 Bianco LGF33068BTP
- G40 Nero LGF33040BTP

#### CLASSIC

- G62 Bianco Antico LGF33062BTP
- G59 Antracite LGF33059BTP
- G51 Avena LGF33051BTP

### ACCESSORI CONSIGLIATI

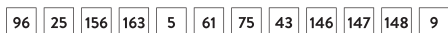

## FOX 200



Lavello 1 vasca

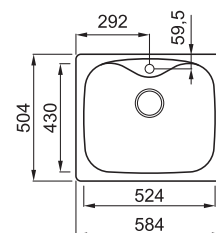

### CARATTERISTICHE

Dimensioni (mm)	<b>584 x 504</b>
Base (mm)	<b>600</b>
Foro da incasso (mm)	<b>560 x 480 R32</b>
Profondità Vasca (mm)	<b>230</b>
Orientamento	<b>Non reversibile</b>

Disegno Tecnico approfondito: QR code a pag. 153

### MATERIALI E COLORI

**GRANITEK**  
NATURAL GRANITE EFFECT

Euro **349**

#### METAL

- M79 Aluminium LMF20079
- M73 Titanium LMF20073

**GRANITEK**  
NATURAL GRANITE EFFECT

Euro **328**

#### MATT

- G68 Bianco LGF20068
- G40 Nero LGF20040

#### CLASSIC

- G62 Bianco Antico LGF20062
- G59 Antracite LGF20059
- G55 Grigio Pietra LGF20055
- G54 Nero Pietra LGF20054
- G52 Bianco Pietra LGF20052
- G51 Avena LGF20051

### ACCESSORI CONSIGLIATI

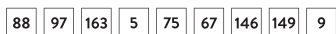

88 Element Tagliere  
Sliding 50cm



ATH010QU  
Euro **136**  
Pag. 176

Solo Fox 200

156 Element Rollmat 500



ARS023BK  
Euro **82**  
Pag. 181

Esclusi Fox 200/Round

146 Cover piletta



ACPM1000  
Euro **19**  
Pag. 187

## FOX 180



Lavello 1 vasca

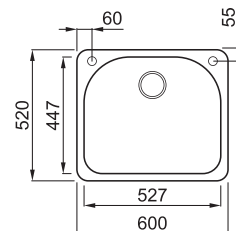

### MATERIALI E COLORI

**GRANITEK**  
NATURAL GRANITE EFFECT

Euro **362**

MATT

- G68 Bianco LGF18068BTP
- G40 Nero LGF18040BTP

CLASSIC

- G62 Bianco Antico LGF18062BTP
- G59 Antracite LGF18059BTP
- G51 Avena LGF18051BTP

Disegno Tecnico approfondito: QR code a pag. 153

### CARATTERISTICHE

Dimensioni (mm)	<b>600 x 520</b>
Base (mm)	<b>600</b>
Foro da incasso (mm)	<b>580 x 510 R32</b>
Profondità Vasca (mm)	<b>215</b>
Orientamento	<b>Non reversibile</b>

### ACCESSORI CONSIGLIATI



## FOX ROUND



Lavello 1 vasca

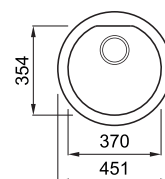

### MATERIALI E COLORI

**GRANITEK**  
NATURAL GRANITE EFFECT

Euro **266**

MATT

- G68 Bianco LGFROU68
- G40 Nero LGFROU40

CLASSIC

- G62 Bianco Antico LGFROU62
- G59 Antracite LGFROU59
- G51 Avena LGFROU51

### ACCESSORIO CONSIGLIATO CESTELLO ROUND

ACI02301 Euro **65**



Installazione miscelatore sul top

### CARATTERISTICHE

Dimensioni (mm)	<b>ø 451</b>
Base (mm)	<b>450</b>
Foro da incasso (mm)	<b>ø 430</b>
Profondità Vasca (mm)	<b>200</b>
Orientamento	<b>Non reversibile</b>

### ACCESSORI CONSIGLIATI

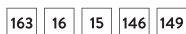

#### 16 Tagliere in legno round



ATL02301  
Euro **78**  
Pag. 186

#### 15 Cestello Round



ACI02301  
Euro **65**  
Pag. 186

Solo Fox Round

#### 161 Kit 3 Spugne Fast Clean



DKP01000  
Pag. 184









COLLEZIONE  
**MASTER**

---

DAL DESIGN FORTEMENTE  
CALDO



COLLEZIONE

# MASTER

Una collezione di lavelli dal design country, perfetto per chi preferisce un ambiente caldo e classico ma con una forte personalità. Ogni modello è combinabile con numerosi accessori e molteplici colorazioni.



SOPRATOP



Lavello Master 550 G51 Avena con miscelatore Elba G51 Avena

1000

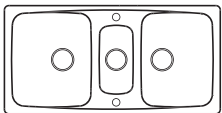

**MASTER 550**  
PAG. 162

800

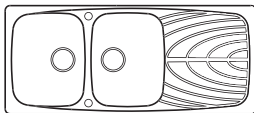

**MASTER 500**  
PAG. 162

600

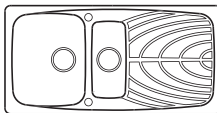

**MASTER 475**  
PAG. 163

900

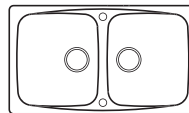

**MASTER 450**  
PAG. 163

450

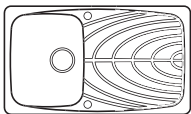

**MASTER 400**  
PAG. 164

800

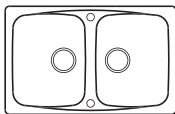

**MASTER 350**  
PAG. 164

450

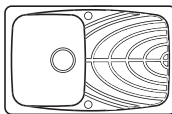

**MASTER 300**  
PAG. 165



DISEGNI TECNICI  
APPROFONDITI  
LINEA MASTER

**Corredo del lavello:** Sifone salvaspazio, pilette e ganci.

**GRANITEK**  
NATURAL GRANITE EFFECT



**M79** Aluminium



**M73** Titanium

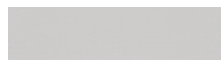

**G68** Bianco



**G40** Nero

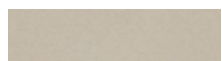

**G62** Bianco Antico



**G59** Antracite



**G55** Grigio Pietra



**G54** Nero Pietra

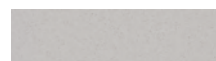

**G52** Bianco Pietra



**G51** Avena



**VASCA CON ANGOLI  
ARROTONDATI**

I bordi interni arrotondati delle vasche conferiscono al lavello quel gusto vintage che è tornato prepotentemente di moda. Un classico che non tramonta mai.



**ACCESSORI ELEMENT**

Tagliere, rollmat e pop up permettono di completare il lavello a proprio gusto e piacimento, rendendo le operazioni di preparazione del cibo più facili e pratiche.



**ACCESSORIO KIT  
PILETTA OTTONATA**

L'accessorio piletta ottonata conferisce al lavello una sensazione di matericità tattile, nobilitando gli arredi e diventando protagonista di nuove sperimentazioni cromatiche.



# MASTER 550



Lavello 2 vasche ½

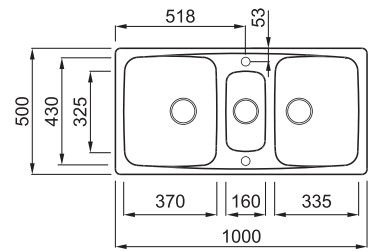

Disegno Tecnico approfondito: QR code a pag. 161

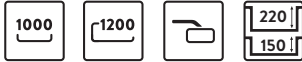

## MATERIALI E COLORI

**GRANITEK**  
NATURAL GRANITE EFFECT Euro **415**

CLASSIC

● G51 Avena LGM55051

## CARATTERISTICHE

Dimensioni (mm)	<b>1000 x 500</b>
Base (mm)	<b>1000</b>
- se inizio composizione	<b>1200</b>
Foro da incasso (mm)	<b>980 x 480</b>
Profondità Vasca 1 (mm)	<b>220</b>
Profondità Vasca 2 (mm)	<b>220</b>
Profondità Vasca 3 (mm)	<b>150</b>
Orientamento	<b>Reversibile</b>

## ACCESSORI CONSIGLIATI



# MASTER 500



Lavello 2 vasche con gocciolatoio

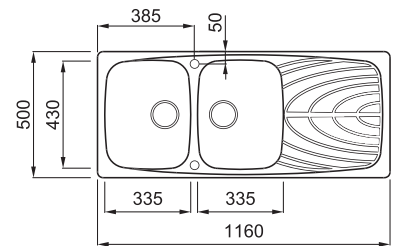

Disegno Tecnico approfondito: QR code a pag. 161



## MATERIALI E COLORI

**GRANITEK**  
NATURAL GRANITE EFFECT Euro **399**

METAL

● M79 Aluminium LMM50079  
● M73 Titanium LMM50073

**GRANITEK**  
NATURAL GRANITE EFFECT Euro **381**

MATT

● G68 Bianco LGM50068  
● G40 Nero LGM50040

CLASSIC

● G62 Bianco Antico LGM50062  
● G59 Antracite LGM50059  
● G55 Grigio Pietra LGM50055  
● G54 Nero Pietra LGM50054  
● G52 Bianco Pietra LGM50052  
● G51 Avena LGM50051

## CARATTERISTICHE

Dimensioni (mm)	<b>1160 x 500</b>
Base (mm)	<b>800</b>
Foro da incasso (mm)	<b>1140 x 480</b>
Profondità Vasca 1 (mm)	<b>220</b>
Profondità Vasca 2 (mm)	<b>220</b>
Orientamento	<b>Reversibile</b>

## ACCESSORI CONSIGLIATI

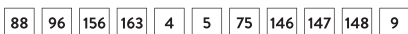

88 Element Tagliere Sliding 50cm



ATH010OL  
Euro **136**  
Pag. 176

156 Element Rollmat 500

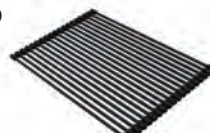

ARS023BK  
Euro **82**  
Pag. 181

148 Kit Piletta 2 vie e troppopieno ottonati



APM2VSCTPGO  
Euro **114**  
Pag. 187

# MASTER 475



## CARATTERISTICHE

Dimensioni (mm)	<b>1000 x 500</b>
Base (mm)	<b>600</b>
Foro da incasso (mm)	<b>980 x 480</b>
Profondità Vasca 1 (mm)	<b>220</b>
Profondità Vasca 2 (mm)	<b>140</b>
Orientamento	<b>Reversibile</b>

## ACCESSORI CONSIGLIATI

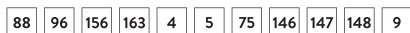

# MASTER 450



## CARATTERISTICHE

Dimensioni (mm)	<b>860 x 500</b>
Base (mm)	<b>900</b>
Foro da incasso (mm)	<b>840 x 480</b>
Profondità Vasca 1 (mm)	<b>220</b>
Profondità Vasca 2 (mm)	<b>220</b>
Orientamento	<b>Reversibile</b>

## ACCESSORI CONSIGLIATI



4 Tagliere scorrevole in legno



ATL01000  
Euro **92**  
Pag. 186

5 Colander

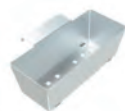

AVI03001  
Euro **116**  
Pag. 186

160 Spray Detergente Sgrassante Daily Clean



DLL01601  
Pag. 183

## Lavello 1 vasca ½ con gocciolatoio

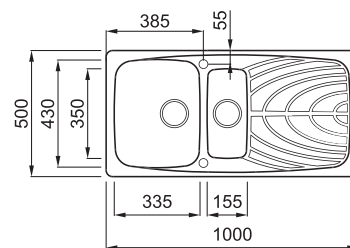

Disegno Tecnico approfondito: QR code a pag. 161

## MATERIALI E COLORI

**GRANITEK**  
NATURAL GRANITE EFFECT

Euro **395**

METAL

- M79 Aluminium LMM47579
- M73 Titanium LMM47573

**GRANITEK**  
NATURAL GRANITE EFFECT

Euro **379**

MATT

- G68 Bianco LGM47568
- G40 Nero LGM47540

CLASSIC

- G62 Bianco Antico LGM47562
- G59 Antracite LGM47559
- G55 Grigio Pietra LGM47555
- G54 Nero Pietra LGM47554
- G52 Bianco Pietra LGM47552
- G51 Avena LGM47551

## Lavello 2 vasche

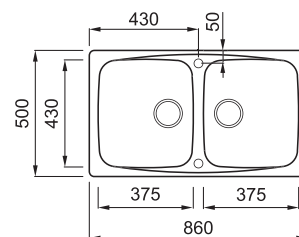

Disegno Tecnico approfondito: QR code a pag. 161

## MATERIALI E COLORI

**GRANITEK**  
NATURAL GRANITE EFFECT

Euro **365**

METAL

- M79 Aluminium LMM45079
- M73 Titanium LMM45073

**GRANITEK**  
NATURAL GRANITE EFFECT

Euro **350**

MATT

- G68 Bianco LGM45068
- G40 Nero LGM45040

CLASSIC

- G62 Bianco Antico LGM45062
- G59 Antracite LGM45059
- G55 Grigio Pietra LGM45055
- G54 Nero Pietra LGM45054
- G52 Bianco Pietra LGM45052
- G51 Avena LGM45051



## MASTER 400



Lavello 1 vasca con gocciolatoio

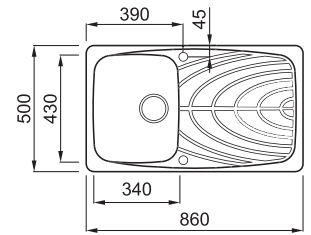

Disegno Tecnico approfondito: QR code a pag. 161



### CARATTERISTICHE

Dimensioni (mm)	<b>860 x 500</b>
Base (mm)	<b>450</b>
Foro da incasso (mm)	<b>840 x 480</b>
Profondità Vasca (mm)	<b>220</b>
Orientamento	<b>Reversibile</b>

### ACCESSORI CONSIGLIATI



### MATERIALI E COLORI

**GRANITEK**  
NATURAL GRANITE EFFECT

Euro **345**

#### METAL

- M79 Aluminium LMM40079
- M73 Titanium LMM40073

**GRANITEK**  
NATURAL GRANITE EFFECT

Euro **328**

#### MATT

- G68 Bianco LGM40068
- G40 Nero LGM40040

#### CLASSIC

- G62 Bianco Antico LGM40062
- G59 Antracite LGM40059
- G55 Grigio Pietra LGM40055
- G54 Nero Pietra LGM40054
- G52 Bianco Pietra LGM40052
- G51 Avena LGM40051

## MASTER 350



Lavello 2 vasche

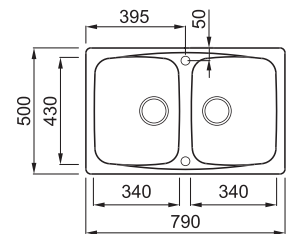

Disegno Tecnico approfondito: QR code a pag. 161



### CARATTERISTICHE

Dimensioni (mm)	<b>790 x 500</b>
Base (mm)	<b>800</b>
- se inizio composizione	<b>900</b>
Foro da incasso (mm)	<b>770 x 480</b>
Profondità Vasca 1 (mm)	<b>220</b>
Profondità Vasca 2 (mm)	<b>220</b>
Orientamento	<b>Reversibile</b>

### ACCESSORI CONSIGLIATI



### MATERIALI E COLORI

**GRANITEK**  
NATURAL GRANITE EFFECT

Euro **365**

#### METAL

- M79 Aluminium LMM35079
- M73 Titanium LMM35073

**GRANITEK**  
NATURAL GRANITE EFFECT

Euro **350**

#### MATT

- G68 Bianco LGM35068
- G40 Nero LGM35040

#### CLASSIC

- G62 Bianco Antico LGM35062
- G59 Antracite LGM35059
- G55 Grigio Pietra LGM35055
- G54 Nero Pietra LGM35054
- G52 Bianco Pietra LGM35052
- G51 Avena LGM35051

88 Element Tagliere Sliding 50cm



ATH010OL  
Euro **136**  
Pag. 176

156 Element Rollmat 500

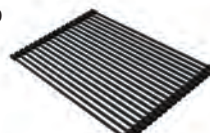

ARS023BK  
Euro **82**  
Pag. 181

149 Kit Piletta 1 via e troppopieno ottonato



APM1VCTPGO  
Euro **64**  
Pag. 187

# MASTER 300



Lavello 1 vasca con gocciolatoio

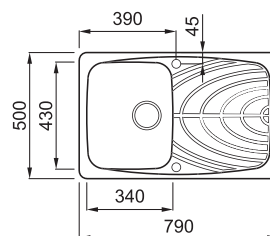

Disegno Tecnico approfondito: QR code a pag. 161



## CARATTERISTICHE

Dimensioni (mm)	<b>790 x 500</b>
Base (mm)	<b>450</b>
Foro da incasso (mm)	<b>770 x 480</b>
Profondità Vasca (mm)	<b>220</b>
Orientamento	<b>Reversibile</b>

## ACCESSORI CONSIGLIATI



## MATERIALI E COLORI

**GRANITEK**  
NATURAL GRANITE EFFECT

Euro **345**

METAL

	M79 Aluminium	LMM30079
	M73 Titanium	LMM30073

**GRANITEK**  
NATURAL GRANITE EFFECT

Euro **328**

MATT

	G68 Bianco	LGM30068
	G40 Nero	LGM30040

CLASSIC

	G62 Bianco Antico	LGM30062
	G59 Antracite	LGM30059
	G55 Grigio Pietra	LGM30055
	G54 Nero Pietra	LGM30054
	G52 Bianco Pietra	LGM30052
	G51 Avena	LGM30051

**97** Element Pop-Up  
Push Control



ASP13002  
Euro **35**  
Pag. 179

**75** Cestello



ACI01307  
Euro **93**  
Pag. 186

**158** Spray Anticalcare  
Disincrostante Daily Clean



DLA01601  
Pag. 184





COLLEZIONE

# LIVING

---

DAL DESIGN SEMPLICE  
E FUNZIONALE







COLLEZIONE

# LIVING

Una collezione di lavelli classica che con la loro semplicità e le molteplici dimensioni rendono l'ambiente perfettamente funzionale. È possibile associare ad ogni lavello una serie di accessori per aumentarne la funzionalità.



SOPRATOP



Lavello Living 300 G62 Bianco Antico con miscelatore Rio G62 Bianco Antico



800

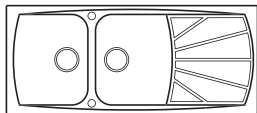

**LIVING 500**  
PAG. 170

600

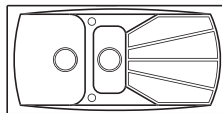

**LIVING 475**  
PAG. 170

900

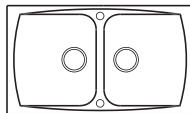

**LIVING 450**  
PAG. 171

450

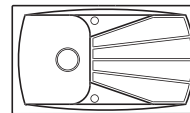

**LIVING 400**  
PAG. 171

450

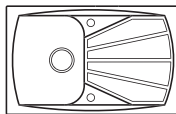

**LIVING 300**  
PAG. 172

450

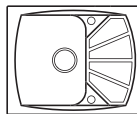

**LIVING 125**  
PAG. 172



DISEGNI TECNICI  
APPROFONDITI  
LINEA LIVING

**Corredo del lavello:** Sifone salvaspazio, pilette e ganci.

**GRANITEK**  
NATURAL GRANITE EFFECT



**M79** Aluminium



**M73** Titanium

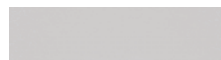

**G68** Bianco



**G43** Tortora



**G40** Nero

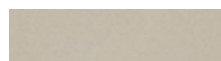

**G62** Bianco Antico



**G59** Antracite



**G55** Grigio Pietra



**G54** Nero Pietra

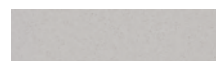

**G52** Bianco Pietra



**G51** Avena



**VASCA CON ANGOLI  
ARROTONDATI**

I bordi interni arrotondati delle vasche conferiscono al lavello quel gusto vintage che è tornato prepotentemente di moda. Un classico che non tramonta mai.



**ACCESSORI ELEMENT**

Tagliere, rollmat e pop up permettono di completare il lavello a proprio gusto e piacimento, rendendo le operazioni di preparazione del cibo più facili e pratiche.



**ACCESSORIO KIT  
PILETTA OTTONATA**

L'accessorio piletta ottonata conferisce al lavello una sensazione di matericità tattile, nobilitando gli arredi e diventando protagonista di nuove sperimentazioni cromatiche.

## LIVING 500



### CARATTERISTICHE

Dimensioni (mm)	<b>1160 x 500</b>
Base (mm)	<b>800</b>
Foro da incasso (mm)	<b>1140 x 480</b>
Profondità Vasca 1 (mm)	<b>210</b>
Profondità Vasca 2 (mm)	<b>210</b>
Orientamento	<b>Reversibile</b>

### ACCESSORI CONSIGLIATI

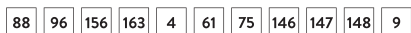

### Lavello 2 vasche con gocciolatoio

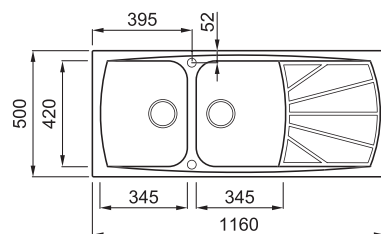

Disegno Tecnico approfondito: QR code a pag. 169

### MATERIALI E COLORI

<b>GRANITEK</b> NATURAL GRANITE EFFECT	Euro <b>358</b>
METAL	
● M79 Aluminium	LML50079
● M73 Titanium	LML50073

<b>GRANITEK</b> NATURAL GRANITE EFFECT	Euro <b>344</b>
MATT	
● G68 Bianco	LGL50068
● G43 Tortora	LGL50043
● G40 Nero	LGL50040
CLASSIC	
● G62 Bianco Antico	LGL50062
● G59 Antracite	LGL50059
● G55 Grigio Pietra	LGL50055
● G54 Nero Pietra	LGL50054
● G52 Bianco Pietra	LGL50052
● G51 Avena	LGL50051

## LIVING 475



### CARATTERISTICHE

Dimensioni (mm)	<b>1000 x 500</b>
Base (mm)	<b>600</b>
Foro da incasso (mm)	<b>980 x 480</b>
Profondità Vasca 1 (mm)	<b>210</b>
Profondità Vasca 2 (mm)	<b>165</b>
Orientamento	<b>Reversibile</b>

### ACCESSORI CONSIGLIATI

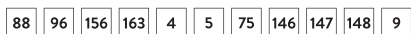

### Lavello 1 vasca 1/2 con gocciolatoio

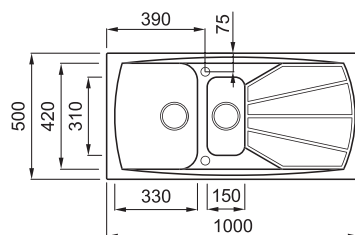

Disegno Tecnico approfondito: QR code a pag. 169

### MATERIALI E COLORI

<b>GRANITEK</b> NATURAL GRANITE EFFECT	Euro <b>356</b>
METAL	
● M79 Aluminium	LML47579
● M73 Titanium	LML47573

<b>GRANITEK</b> NATURAL GRANITE EFFECT	Euro <b>339</b>
MATT	
● G68 Bianco	LGL47568
● G43 Tortora	LGL47543
● G40 Nero	LGL47540
CLASSIC	
● G62 Bianco Antico	LGL47562
● G59 Antracite	LGL47559
● G55 Grigio Pietra	LGL47555
● G54 Nero Pietra	LGL47554
● G52 Bianco Pietra	LGL47552
● G51 Avena	LGL47551

88 Element Tagliere Sliding 50cm



ATH010QU  
Euro **136**  
Pag. 176

156 Element Rollmat 500



ARS023BK  
Euro **82**  
Pag. 181

75 Cestello



ACI01307  
Euro **93**  
Pag. 186

# LIVING 450



Lavello 2 vasche

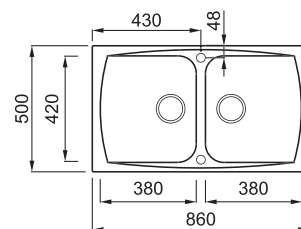

## CARATTERISTICHE

Dimensioni (mm)	<b>860 x 500</b>
Base (mm)	<b>900</b>
Foro da incasso (mm)	<b>840 x 480</b>
Profondità Vasca 1 (mm)	<b>210</b>
Profondità Vasca 2 (mm)	<b>210</b>
Orientamento	<b>Reversibile</b>

## ACCESSORI CONSIGLIATI



## MATERIALI E COLORI

**GRANITEK**  
NATURAL GRANITE EFFECT

Euro **328**

METAL

- M79 Aluminium LML45079
- M73 Titanium LML45073

**GRANITEK**  
NATURAL GRANITE EFFECT

Euro **315**

MATT

- G68 Bianco LGL45068
- G43 Tortora LGL45043
- G40 Nero LGL45040

CLASSIC

- G62 Bianco Antico LGL45062
- G59 Antracite LGL45059
- G55 Grigio Pietra LGL45055
- G54 Nero Pietra LGL45054
- G52 Bianco Pietra LGL45052
- G51 Avena LGL45051

Disegno Tecnico approfondito: QR code a pag. 169

# LIVING 400



Lavello 1 vasca con gocciolatoio

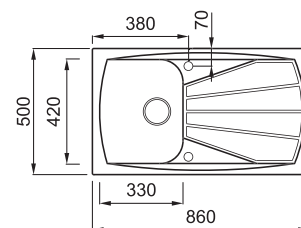

## CARATTERISTICHE

Dimensioni (mm)	<b>860 x 500</b>
Base (mm)	<b>450</b>
Foro da incasso (mm)	<b>840 x 480</b>
Profondità Vasca (mm)	<b>210</b>
Orientamento	<b>Reversibile</b>

## ACCESSORI CONSIGLIATI

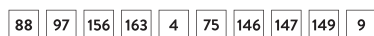

## MATERIALI E COLORI

**GRANITEK**  
NATURAL GRANITE EFFECT

Euro **309**

METAL

- M79 Aluminium LML40079
- M73 Titanium LML40073

**GRANITEK**  
NATURAL GRANITE EFFECT

Euro **297**

MATT

- G68 Bianco LGL40068
- G43 Tortora LGL40043
- G40 Nero LGL40040

CLASSIC

- G62 Bianco Antico LGL40062
- G59 Antracite LGL40059
- G55 Grigio Pietra LGL40055
- G54 Nero Pietra LGL40054
- G52 Bianco Pietra LGL40052
- G51 Avena LGL40051

Disegno Tecnico approfondito: QR code a pag. 169

4 Tagliere scorrevole in legno



ATL01000  
Euro **92**  
Pag. 186

5 Colander

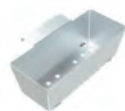

AVI03001  
Euro **116**  
Pag. 186

Solo Living 475

162 Panni in Microfibra Fast Clean

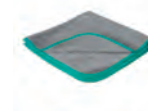

AMP01001  
Pag. 185



## LIVING 300



### CARATTERISTICHE

Dimensioni (mm)	<b>790 x 500</b>
Base (mm)	<b>450</b>
Foro da incasso (mm)	<b>770 x 480</b>
Profondità Vasca (mm)	<b>210</b>
Orientamento	<b>Reversibile</b>

### ACCESSORI CONSIGLIATI



### Lavello 1 vasca con gocciolatoio

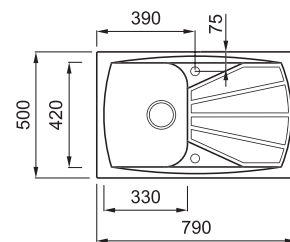

Disegno Tecnico approfondito: QR code a pag. 169

### MATERIALI E COLORI

<b>GRANITEK</b> NATURAL GRANITE EFFECT	Euro <b>309</b>
METAL	
● M79 Aluminium	LML30079
● M73 Titanium	LML30073

<b>GRANITEK</b> NATURAL GRANITE EFFECT	Euro <b>297</b>
MATT	
● G68 Bianco	LGL30068
● G43 Tortora	LGL30043
● G40 Nero	LGL30040
CLASSIC	
● G62 Bianco Antico	LGL30062
● G59 Antracite	LGL30059
● G55 Grigio Pietra	LGL30055
● G54 Nero Pietra	LGL30054
● G52 Bianco Pietra	LGL30052
● G51 Avena	LGL30051

## LIVING 125



### CARATTERISTICHE

Dimensioni (mm)	<b>610 x 500</b>
Base (mm)	<b>450</b>
Foro da incasso (mm)	<b>600 x 495</b>
Profondità Vasca (mm)	<b>190</b>
Orientamento	<b>Reversibile</b>

### ACCESSORI CONSIGLIATI

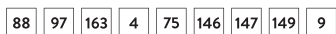

### Lavello 1 vasca con gocciolatoio

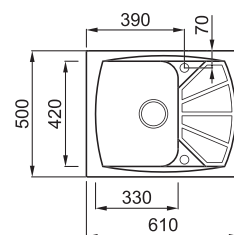

Disegno Tecnico approfondito: QR code a pag. 169

### MATERIALI E COLORI

<b>GRANITEK</b> NATURAL GRANITE EFFECT	Euro <b>285</b>
METAL	
● M79 Aluminium	LML12579
● M73 Titanium	LML12573

<b>GRANITEK</b> NATURAL GRANITE EFFECT	Euro <b>273</b>
MATT	
● G68 Bianco	LGL12568
● G43 Tortora	LGL12543
● G40 Nero	LGL12540
CLASSIC	
● G62 Bianco Antico	LGL12562
● G59 Antracite	LGL12559
● G55 Grigio Pietra	LGL12555
● G54 Nero Pietra	LGL12554
● G52 Bianco Pietra	LGL12552
● G51 Avena	LGL12551

88 Element Tagliere  
Sliding 50cm



ATH0100L  
Euro **136**  
Pag. 176

156 Element Rollmat 500

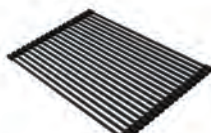

ARS023BK  
Euro **82**  
Pag. 181

Solo Living 300

146 Cover piletta



ACPM1000  
Euro **19**  
Pag. 187



149 Kit Piletta 1 via e troppopieno ottonato



APMIVCTPGO  
Euro **64**  
Pag. 187

97 Element Pop-Up Push Control



ASP13002  
Euro **35**  
Pag. 179

161 Kit 3 Spugne Fast Clean



DKP01000  
Pag. 184



COLLEZIONE

# ACCESSORI





# ALLA SCOPERTA DI NUOVE SENSAZIONI

CON GLI ACCESSORI ELLECI SARÀ SEMPRE POSSIBILE CONFERIRE ALL'AMBIENTE CUCINA IL PROPRIO TOCCO PERSONALE, ESATTAMENTE COME TU DESIDERI.

Nuovi materiali, nuove finiture: sensazioni materiche e semplicità d'uso si fondono in un perfetto connubio di design e funzionalità.

## ACCESSORI ELEMENT

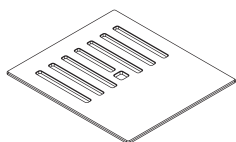

**ELEMENT TAGLIERI**  
PAG. 176

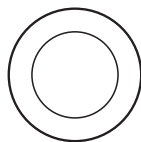

**ELEMENT POP-UP**  
PAG. 179

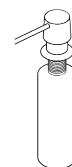

**ELEMENT DISPENSER**  
PAG. 180

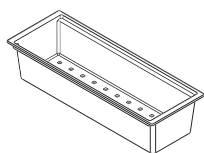

NEW

**ELEMENT COLANDER**  
PAG. 181

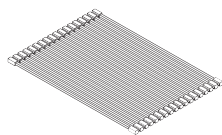

NEW

**ELEMENT ROLLMAT**  
PAG. 181

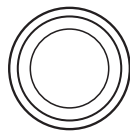

NEW

**ELEMENT STYLE**  
PAG. 182



NEW

**ELLECI BEAUTY**  
PAG. 183

## ACCESSORI VARI

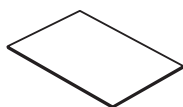

**TAGLIERI**  
PAG. 186

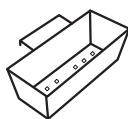

**COLANDER**  
PAG. 186



**CESTELLI**  
PAG. 186

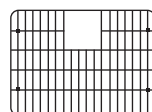

**BOTTOM GRID**  
PAG. 187



**ALTRI ACCESSORI**  
PAG. 187

## 88 ELEMENT TAGLIERE SLIDING 50CM

TAGLIERE MULTIFUNZIONE IN HPL

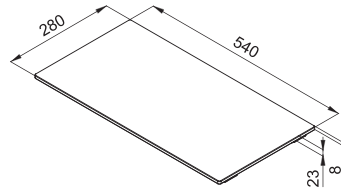

### CARATTERISTICHE

Dimensione (mm) Euro  
**280 x 540 x 23** **136**

### COLORI DISPONIBILI

 Nero  
ATH010BK

 Grigio  
ATH010GR

 Quercia  
ATH010QU

 Olmo  
ATH010OL

### COMPATIBILITÀ COLLEZIONE

KARISMA

EGO

UNICO

EASY

TEKNO

FOX

MASTER

LIVING

SKY

Solo Sopratop

Escluso Round

Esclusi 425/290/Corner/Round 600

Esclusi Fox 360/340/330/180/Round

Escluso Round 435

## 89 ELEMENT TAGLIERE BEST LINE

TAGLIERE MULTIFUNZIONE IN HPL

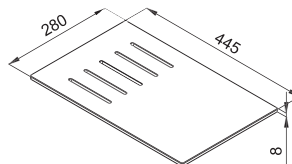
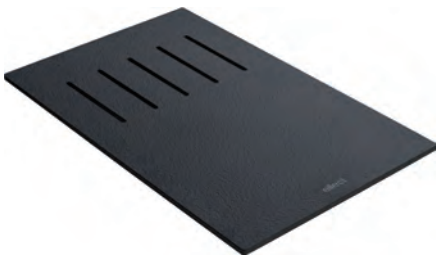

### CARATTERISTICHE

Dimensione (mm) Euro  
**280 x 445 x 8** **113**

### COLORI DISPONIBILI

 Nero  
ATH020BK

 Grigio  
ATH020GR

 Quercia  
ATH020QU

 Olmo  
ATH020OL

### COMPATIBILITÀ COLLEZIONE

BEST

Esclusi Best 360 e Best 130

## 155 ELEMENT TAGLIERE FOX 360

NEW

TAGLIERE MULTIFUNZIONE IN HPL CON VASCHETTA

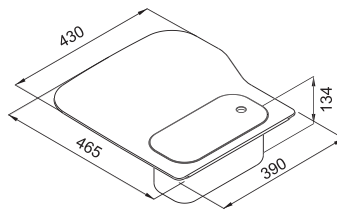

### CARATTERISTICHE

Dimensione (mm) Euro  
**430 x 465 x 134** **165**

### COLORI DISPONIBILI

 Quercia  
ATH130QU

 Olmo  
ATH130OL

### COMPATIBILITÀ LAVELLO

FOX 360

## 91 ELEMENT TAGLIERE 420

TAGLIERE MULTIFUNZIONE IN HPL

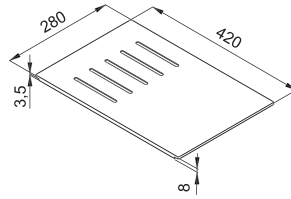

### CARATTERISTICHE

Dimensione (mm) Euro  
**280 x 420 x 8** **113**

### COLORI DISPONIBILI

 Nero ATH040BK  
 Grigio ATH040GR  
 Quercia ATH040QU  
 Olmo ATH040OL

### COMPATIBILITÀ COLLEZIONE

INTEGRA ZEN QUADRA SOPRATOP W-SQUARE YOGA CUBE

Escluso 50/340/440

## 92 ELEMENT TAGLIERE SMART LINE

TAGLIERE MULTIFUNZIONE IN HPL

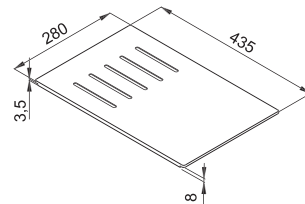

### CARATTERISTICHE

Dimensione (mm) Euro  
**280 x 435 x 8** **113**

### COLORI DISPONIBILI

 Nero ATH050BK  
 Grigio ATH050GR  
 Quercia ATH050QU  
 Olmo ATH050OL

### COMPATIBILITÀ COLLEZIONE

SMART

## 93 ELEMENT TAGLIERE BEST WORKSTATION

TAGLIERE MULTIFUNZIONE IN HPL

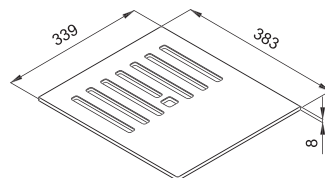

### CARATTERISTICHE

Dimensione (mm) Euro  
**339 x 383 x 8** **117**

### COLORI DISPONIBILI

 Nero ATH073BK  
 Grigio ATH073GR  
 Quercia ATH073QU  
 Olmo ATH073OL

### COMPATIBILITÀ LAVELLI

BEST 360 BEST 130



## 94 ELEMENT MINI PIASTRA SMART

PIASTRA IN HPL

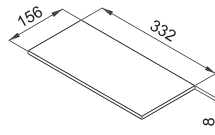

### CARATTERISTICHE

Dimensione (mm) Euro  
**156 x 332 x 8** **92**

### COLORI DISPONIBILI



Nero  
ATH063BK



Grigio  
ATH063GR



Quercia  
ATH063QU



Olmo  
ATH063OL

### COMPATIBILITÀ COLLEZIONE

SMART

Escluso 450

## 154 ELEMENT TAGLIERE GLOBE 910

NEW

TAGLIERE MULTIFUNZIONE IN HPL

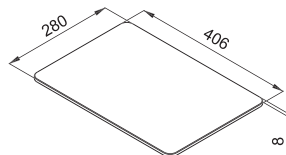

### CARATTERISTICHE

Dimensione (mm) Euro  
**280 x 406 x 8** **113**

### COLORI DISPONIBILI



Olmo  
ATHPL090OL

### COMPATIBILITÀ LAVELLO

GLOBE 910

## 95 ELEMENT KIT DOGHE VALUE

DOGHE IN HPL

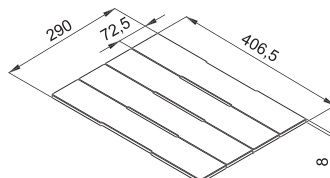

### CARATTERISTICHE

Dimensione (mm) Euro  
**290 x 406 x 8** **95**

### COLORI DISPONIBILI



Nero  
ATH083BK



White  
ATH083WH

### COMPATIBILITÀ COLLEZIONE

VALUE

## 96 ELEMENT POP-UP PUSH CONTROL 2 VIE

KIT PILETTA AUTOMATICA A 2 VIE

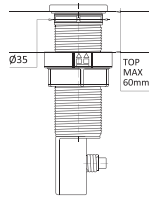
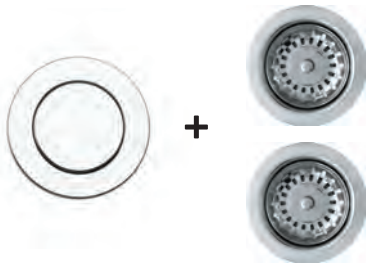

### CARATTERISTICHE

Dimensione foro di incasso (mm)

Ø 35

### COLORI DISPONIBILI



CR Cromato  
ASP23002

Euro

66



Nero  
ASP23002BK

Euro

120

**COMPATIBILITÀ COLLEZIONE** Solo lavelli a 2 vasche con installazione sopratop

BEST   QUADRA   UNICO   EGO   TEKNO   EASY   FOX   MASTER   LIVING

## 97 ELEMENT POP-UP PUSH CONTROL

KIT PILETTA AUTOMATICA A 1 VIA

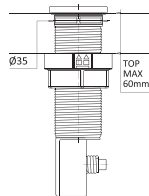

### CARATTERISTICHE

Dimensione foro di incasso (mm)

Ø 35

### COLORI DISPONIBILI



CR Cromato  
ASP13002

Euro

35



Nero  
ASP13002BK

Euro

88

**COMPATIBILITÀ COLLEZIONE** Solo lavelli a 1 vasca con installazione sopratop

BEST WORKSTATION   BEST   QUADRA   UNICO   EGO   TEKNO   EASY   FOX   MASTER   LIVING  
Escluso Round

## 98 ELEMENT POP-UP PUSH CONTROL KARISMA

KIT PILETTA QUADRATA AUTOMATICA A 1 VIA

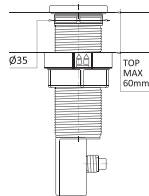

### CARATTERISTICHE

Dimensione foro di incasso (mm) Euro

Ø 35

56

### COLORI DISPONIBILI



CR Cromato  
ASP16302

**COMPATIBILITÀ COLLEZIONE**

KARISMA

Solo Sopratop

## 99 ELEMENT POP-UP CUBE VALUE

KIT PILETTA AUTOMATICA ROTATIVA

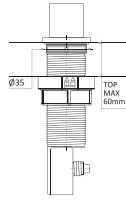
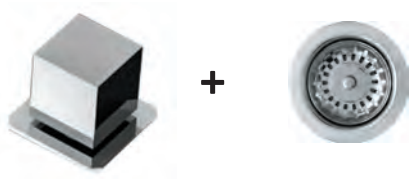

### CARATTERISTICHE

Dimensione foro di incasso (mm) Euro  
**Ø 35 87**

### COLORI DISPONIBILI

●  
 CR Cromato  
 ASP17000

### COMPATIBILITÀ COLLEZIONE

VALUE

## 25 ELEMENT DISPENSER SAPONE TONDO

DISPENSER SAPONE

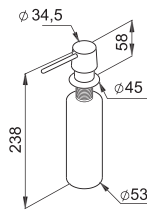

### CARATTERISTICHE

Dimensione foro di incasso (mm)  
**Ø 35**

### COLORI DISPONIBILI

● Euro  
 CR Cromato  
 ADI02300 **38**

● Euro  
 Nero  
 ADI02300BK **60**

### COMPATIBILITÀ COLLEZIONE

BEST WORKSTATION

QUADRA  
 Escluso 50

UNICO  
 Escluso 500

EASY  
 Esclusi 500/Round 600

FOX  
 Esclusi 450/200/Round

## 50 ELEMENT DISPENSER SAPONE QUADRATO

DISPENSER SAPONE

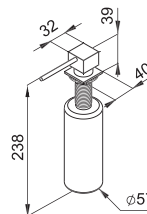

### CARATTERISTICHE

Dimensione foro di incasso (mm) Euro  
**Ø 35 94**

### COLORI DISPONIBILI

●  
 CR Cromato  
 ADI02301

### COMPATIBILITÀ COLLEZIONE

VALUE

KARISMA  
 Solo Sopratop

BEST WORKSTATION

QUADRA  
 Escluso 50

UNICO  
 Escluso 500

EASY  
 Esclusi 500/Round 600



## 152 ELEMENT COLANDER 418

NEW

COLANDER IN POLIPROPILENE

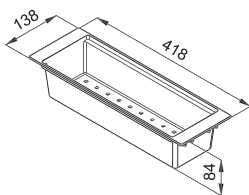

### CARATTERISTICHE

Dimensione (mm) Euro  
**418 x 138 x 84** **60**

### COLORI DISPONIBILI

●  
Nero  
AVP035BK

### COMPATIBILITÀ COLLEZIONE

INTEGRA

ZEN

QUADRA

W-SQUARE

YOGA

CUBE

SKY

Esclusi 50/340/440

Solo 500/480/450/400

## 153 ELEMENT COLANDER BEST WORKSTATION

NEW

COLANDER IN POLIPROPILENE

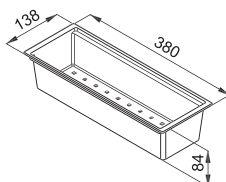

### CARATTERISTICHE

Dimensione (mm) Euro  
**380 x 138 x 84** **60**

### COLORI DISPONIBILI

●  
Nero  
AVP034BK

### COMPATIBILITÀ COLLEZIONE

BEST WORKSTATION

## 156 ELEMENT ROLLMAT 500

NEW

ROLLMAT IN SILICONE CON BARRE IN ACCIAIO RIVESTITE

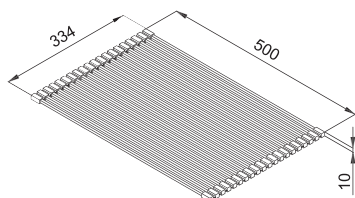

### CARATTERISTICHE

Dimensione (mm) Euro  
**334 x 500 x 10** **82**

### COLORI DISPONIBILI

●  
Nero  
ARS023BK

### COMPATIBILITÀ COLLEZIONE

VALUE

QUADRA

DOGMA

UNICO

SMART

EGO

BEST WORKSTATION

EASY

BEST

FOX

MASTER

LIVING

SKY

Sottotop

Solo 440/340

Esclusi 425/290/135/Corner/Round 600

Esclusi 200/Round

Escluso 125

## 157 ELEMENT ROLLMAT 440

NEW

ROLLMAT IN SILICONE CON BARRE IN ACCIAIO RIVESTITE

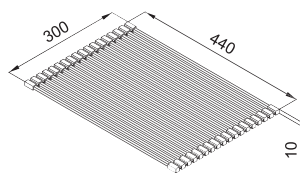

### CARATTERISTICHE

Dimensione (mm) Euro  
**300 x 440 x 10** **74**

### COLORI DISPONIBILI

●  
 Nero  
 ARS013BK

### COMPATIBILITÀ COLLEZIONE

GLOBE

VALUE

Sopratop

KARISMA

INTEGRA

ZEN

QUADRA

Solo 350/200/150/130/110

EASY

Solo 425/290

W-SQUARE

YOGA

CUBE

## 163 ELEMENT COVER PILETTA MATERICA

NEW

COVER PILETTA MATERICA

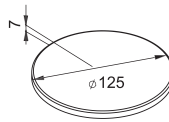

### CARATTERISTICHE

Dimensione (mm) Euro  
**Ø 125** **38**

### COLORI DISPONIBILI

●  
 K99 Dark Grey  
 AKCP1299

●  
 K97 Light Grey  
 AKCP1297

●  
 K96 White  
 AKCP1296

●  
 K95 Champagne  
 AKCP1295

●  
 K93 Dove Grey  
 AKCP1293

### COMPATIBILITÀ COLLEZIONE

TUTTE LE COLLEZIONI

(Escluse Dogma, Smart, Value e Karisma)

●  
 K86 Black  
 AKCP1286

●  
 G68 Bianco  
 AGCP1268

●  
 G48 Cemento  
 AGCP1248

●  
 G43 Tortora  
 AGCP1243

●  
 G40 Nero  
 AGCP1240

## 164 ELEMENT KIT PILETTA E TROPPOPIENO BLACK

NEW

KIT PILETTA E TROPPOPIENO



### CARATTERISTICHE

Dimensione (mm) Euro  
**Ø 114** **68**

### COLORI DISPONIBILI

●  
 Nero  
 COMPP90CTPLUXABK

### COMPATIBILITÀ COLLEZIONE

INTEGRA

ZEN

BEST WORKSTATION

BEST

## 150 CREMA SMACCHIANTE DEEP CLEAN LAVELLI KERATEK

NEW



### AZIONE

Questa crema smacchiante rimuove le macchie ostinate su tutti i lavelli Elleci in Keratek Plus. Il prodotto è indicato per la pulizia straordinaria dei lavelli Elleci.

### MODO D'USO

- Applicare EXTRA ACTION sulla superficie asciutta.
- Lasciare agire per 5/10 minuti.
- Compiere dei piccoli movimenti rotatori con una spugna morbida.
- Risciacquare e asciugare accuratamente con un panno morbido o in microfibra antigraffio.



APPLICA



ATTENDI



PULISCI



RISCIACQUA E ASCIUGA

Codice

DLC01602

## 151 CREMA SMACCHIANTE DEEP CLEAN LAVELLI GRANITEK

NEW



### AZIONE

Questa crema smacchiante rimuove le macchie ostinate su tutti i lavelli Elleci in Granitek. Il prodotto è indicato per la pulizia straordinaria dei lavelli Elleci.

### MODO D'USO

- Applicare EXTRA ACTION sulla superficie asciutta.
- Lasciare agire per 5/10 minuti.
- Compiere dei piccoli movimenti rotatori con una spugna morbida.
- Risciacquare e asciugare accuratamente con un panno morbido o in microfibra antigraffio.



APPLICA



ATTENDI



PULISCI



RISCIACQUA E ASCIUGA

Codice

DLC01601

## 160 SPRAY DETERGENTE SGRASSANTE DAILY CLEAN

NEW



### AZIONE

Questo spray sgrassante agisce rimuovendo le macchie più ostinate rispettando le superfici. Il prodotto è indicato per la pulizia periodica dei lavelli Elleci.

### MODO D'USO

- Spruzzare ACTIVE SGRASSANTE sulla superficie da trattare.
- Lasciare agire qualche secondo.
- Pulire la superficie servendosi di una spugna morbida.
- Risciacquare e asciugare accuratamente la superficie con un panno morbido o in microfibra antigraffio.



SPRUZZA



ATTENDI



PULISCI



RISCIACQUA E ASCIUGA

Codice

DLL01601



## 158 SPRAY ANTICALCARE DISINCROSTANTE DAILY CLEAN

NEW



### AZIONE

Questo spray anticalcare agisce sciogliendo le incrostazioni di calcare rispettando le superfici. Il prodotto è indicato per una pulizia periodica dei lavelli Elleci.

### MODO D'USO

- Spruzzare ACTIVE ANTICALCARE sulla superficie da trattare.
- Lasciare agire qualche secondo.
- Pulire la superficie servendosi di una spugna morbida.
- Risciacquare e asciugare accuratamente la superficie con un panno morbido o in microfibra antigraffio.



SPRUZZA



ATTENDI



PULISCI



RISCIACQUA E ASCIUGA

Codice

DLA01601

## 159 SPRAY DETERGENTE PRODOTTI COLORATI DAILY CLEAN

NEW



### AZIONE

Questo detergente pulisce a fondo e può essere usato su tutte le superfici colorate e smaltate. Il prodotto è adatto per una pulizia quotidiana dei miscelatori e degli elettrodomestici colorati Elleci.

### MODO D'USO

- Spruzzare CLEAN POWER sulla superficie da trattare.
- Lasciare agire qualche secondo.
- Pulire la superficie servendosi di una spugna morbida.
- Risciacquare e asciugare accuratamente la superficie con un panno morbido o in microfibra antigraffio.



SPRUZZA



ATTENDI



PULISCI



RISCIACQUA E ASCIUGA

Codice

DLA01602

## 161 KIT 3 SPUGNE FAST CLEAN

NEW



### FAST CLEAN

Questo kit composto da 3 spugne antigraffio è ideale per togliere i residui e mantenere l'estetica e la funzionalità del tuo prodotto Elleci, facilitano la rimozione delle macchie sulle superfici in composito e colorate dei prodotti Elleci.

Le spugne Fast Clean sono dotate di doppio strato utile a rimuovere lo sporco più intenso. La parte bianca agisce senza graffiare le superfici delicate mentre la parte blu più morbida, ha un potere assorbente.

Codice

DKP01000

## 162 PANNI IN MICROFIBRA FAST CLEAN

NEW

### FAST CLEAN

Questo kit 2 panni in microfibra è perfetto per togliere i residui e mantenere l'estetica e la funzionalità del tuo prodotto Elleci agendo sulla superficie senza lasciare graffi e assorbendo ogni liquido lasciando asciutto il vostro prodotto rimuovendo polvere e sporco.

I panni in microfibra Fast Clean, estremamente assorbenti, sono ideali per asciugare accuratamente le superfici dei prodotti Elleci, grazie al motivo a scacchiera presente sul panno che rimuove ogni residuo.

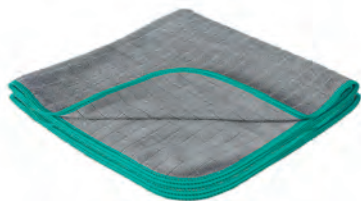

Codice  
AMP01001



## TAGLIERI

### 4 TAGLIERE SCORREVOLE IN LEGNO



#### CARATTERISTICHE

Dimensione (mm) 540 x 300  
Codice ATL01000  
Euro **92**

### 10 TAGLIERE IN LEGNO EGO ROUND



#### CARATTERISTICHE

Dimensione (mm) Ø435  
Codice ATL02300  
Euro **54**

### 16 TAGLIERE IN LEGNO FOX ROUND / SKY ROUND 435



#### CARATTERISTICHE

Dimensione (mm) Ø395  
Codice ATL02301  
Euro **78**

### 46 TAGLIERE SKY 360



#### CARATTERISTICHE

Dimensione (mm) 375 x 435  
Codice ATL01303  
Euro **80**

## COLANDER

### 5 COLANDER

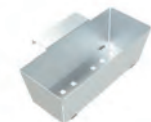

#### CARATTERISTICHE

Dimensione (mm) 322 x 195 x 95  
Codice AVI03001  
Euro **116**

### 51 COLANDER VALUE

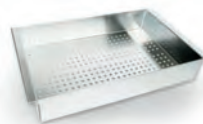

#### CARATTERISTICHE

Dimensione (mm) 250 x 400 x 70  
Codice AVI03303  
Euro **133**

### 61 COLANDER STD L

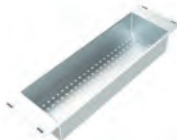

#### CARATTERISTICHE

Dimensione (mm) 462 x 134 x 72  
Codice AVI03305  
Euro **116**

### 63 COLANDER EASY CORNER



#### CARATTERISTICHE

Dimensione (mm) 400 x 284 x 8  
Codice AVI03307  
Euro **108**

### 70 COLANDER BEST LINE

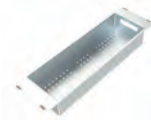

#### CARATTERISTICHE

Dimensione (mm) 444 x 142 x 103  
Codice AVI03000  
Euro **101**

## CESTELLI

### 8 CESTELLO EGO ROUND

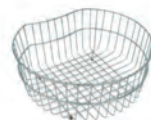

#### CARATTERISTICHE

Dimensione (mm) Ø 345  
Codice ACI02300  
Euro **48**

### 30 CESTELLO SKY



#### CARATTERISTICHE

Dimensione (mm) 348 x 324 x 112  
Codice ACI01304  
Euro **84**

### 15 CESTELLO FOX ROUND / EASY ROUND / SKY ROUND 435



#### CARATTERISTICHE

Dimensione (mm) Ø 320  
Codice ACI02301  
Euro **65**

### 69 CESTELLO BEST LINE



#### CARATTERISTICHE

Dimensione (mm) 444 x 292 x 82  
Codice ACI01306  
Euro **83**

### 75 CESTELLO



#### CARATTERISTICHE

Dimensione (mm) 385 x 270 x 180  
Codice ACI01307  
Euro **93**

### 49 CESTELLO SKY 360



#### CARATTERISTICHE

Dimensione (mm) 375 x 250 x 190  
Codice ACI01305  
Euro **115**



## BOTTOM GRID

### 43 BOTTOM GRID



#### CARATTERISTICHE

Dimensione (mm) 277 x 348  
Codice AGB01300  
Euro **65**

### 67 BOTTOM GRID M



#### CARATTERISTICHE

Dimensione (mm) 445 x 310  
Codice AGB01304  
Euro **82**

### 68 BOTTOM GRID L



#### CARATTERISTICHE

Dimensione (mm) 590 x 334  
Codice AGB01303  
Euro **96**

### 71 BOTTOM GRID S



#### CARATTERISTICHE

Dimensione (mm) 285 x 300  
Codice AGB01306  
Euro **72**

## ALTRI ACCESSORI

### 146 COVER PILETTA



Codice ACPM1000  
Euro **19**

### 147 COVER PILETTA AUTOMATICA



Codice ACPA1000  
Euro **19**

### 148 KIT PILETTA 2 VIE E TROPPOPIENO OTTONATI



Codice APM2VSCTPGO  
Euro **114**

### 149 KIT PILETTA 1 VIA E TROPPOPIENO OTTONATO



Codice APM1VCTPGO  
Euro **64**

### 42 ROLLMAT



#### CARATTERISTICHE

Dimensione (mm) 405 x 337  
Codice ARI01300  
Euro **110**

### 9 SCOLAPIATTI



#### CARATTERISTICHE

Dimensione (mm) 300 x 185 x 82  
Codice ADI01300  
Euro **44**

### 48 VASCHETTA IN POLICARBONATO SKY 360



#### CARATTERISTICHE

Dimensione (mm) 270 x 137 x 60  
Codice AVP01302  
Euro **20**

### 47 VASCHETTA SKY 360



#### CARATTERISTICHE

Dimensione (mm) 274 x 148 x 63  
Codice AVI03002  
Euro **55**

# COLLEZIONE LAVELLI INOX

Configura il tuo lavello Inox.  
Scegli tra collezione, tipologie e accessori  
per configurare il tuo lavello da cucina ideale.

2 ANNI - YEARS  
WARRANTY  
GARANTITO



## SATINATA

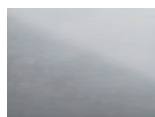

Opaco ma lucente, l'acciaio satinato conserva per anni, inalterati, i suoi valori di eleganza, igiene e resistenza all'usura dell'utilizzo quotidiano.



DISEGNI TECNICI  
APPROFONDITI  
GAMMA INOX

# COLLEZIONE W-SQUARE

Vasche profonde ed alti spessori. Lavello dagli spigoli raggianti per rendere più semplice la pulizia.  
Collezione a Raggio 25 con piletta quadrata dall'estetica ancora più accattivante.  
Collezione W-Square con piletta quadrata, semifilo, filotop e sottotop in acciaio inox AISI 304 18/10.



SEMIFILO



FILOTOP



SOTTOTOP



PROFONDITÀ VASCA  
200 mm



PILETTA  
QUADRATA

## COLLEZIONE

# YOGA NEW

Una serie di eleganti e funzionali vasche dagli spigoli interni raggianti, che è possibile installare in 3 modalità.  
Semifilo: in appoggio sul piano di lavoro. Filotop: con inserimento in un alloggiamento profondo 1 mm ricavato sul top. Sottotop: sotto il piano di lavoro.  
L'elegante disegno del fondo vasca a forma di diamante facilita il deflusso dell'acqua.  
Collezione Yoga in acciaio inox AISI 304 18/10.



SEMIFILO



FILOTOP



SOTTOTOP



PROFONDITÀ VASCA  
200 mm



FONDO  
VASCA DIAMANTATO

## COLLEZIONE

# CUBE NEW

La linea Cube si caratterizza per il Banco Rubinetteria integrato e per le sue linee rigorose e minimal.  
L'elegante disegno del fondo vasca a forma di diamante facilita il deflusso dell'acqua.  
Vasche singole e doppie rettangolari, versatili e pratiche che apportano funzionalità in cucina.  
Collezione Cube in acciaio inox AISI 304 18/10.



SEMIFILO



FILOTOP



PROFONDITÀ VASCA  
200 mm



MUNITO DI FORO  
MISCELATORE



FONDO  
VASCA DIAMANTATO

## COLLEZIONE

# SKY

Per tutto il pianeta cucine. Design puro e semplice che trova posto in tutti i tipi di arredamento.  
Collezione Sky da incasso in acciaio inox AISI 304 18/10.



SOPRATOP



PROFONDITÀ VASCA  
205 - 160 mm



MUNITO DI FORO  
MISCELATORE

# W-SQUARE 700

Lavello 1 vasca

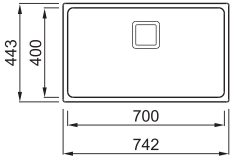

Disegno Tecnico approfondito:  
QR code a pag. 188



## CARATTERISTICHE

Dimensioni (mm)	<b>742 x 443</b>
Raggio Vasca (mm)	<b>25</b>
Base (mm)	<b>800</b>
Foro da incasso (mm)	<b>Semifilo 730 x 430</b>
Foro da incasso (mm)	<b>Filotop 730 x 430</b>
Foro da incasso (mm)	<b>Sottotop 700 x 400 R25</b>
Profondità Vasca (mm)	<b>200</b>
Orientamento	<b>Non reversibile</b>

Installazione miscelatore sul top

Satinata

Euro **443**

LIW700SACMU

## ACCESSORI CONSIGLIATI

152 91 157 75

# W-SQUARE 500

Lavello 1 vasca

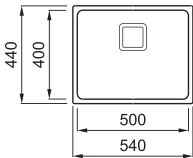

Disegno Tecnico approfondito:  
QR code a pag. 188



## CARATTERISTICHE

Dimensioni (mm)	<b>540 x 440</b>
Raggio Vasca (mm)	<b>25</b>
Base (mm)	<b>600</b>
Foro da incasso (mm)	<b>Semifilo 530 x 430</b>
Foro da incasso (mm)	<b>Filotop 530 x 430</b>
Foro da incasso (mm)	<b>Sottotop 500 x 400 R25</b>
Profondità Vasca (mm)	<b>200</b>
Orientamento	<b>Non reversibile</b>

Installazione miscelatore sul top

Satinata

Euro **366**

LIW500SACMU

## ACCESSORI CONSIGLIATI

152 91 157 75

# W-SQUARE 400

Lavello 1 vasca

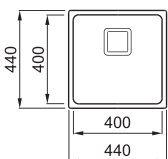

Disegno Tecnico approfondito:  
QR code a pag. 188

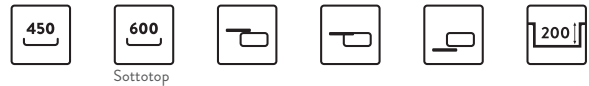

## CARATTERISTICHE

Dimensioni (mm)	<b>440 x 440</b>
Raggio Vasca (mm)	<b>25</b>
Base (mm)	<b>Semifilo/Filotop 450 - Sottotop 600</b>
Foro da incasso (mm)	<b>Semifilo 430 x 430</b>
Foro da incasso (mm)	<b>Filotop 430 x 430</b>
Foro da incasso (mm)	<b>Sottotop 400 x 400 R25</b>
Profondità Vasca (mm)	<b>200</b>
Orientamento	<b>Non reversibile</b>

Installazione miscelatore sul top

Satinata

Euro **316**

LIW400SACMU

## ACCESSORI CONSIGLIATI

152 91 157 75



# YOGA 700

Lavello 1 vasca



**NEW**



## CARATTERISTICHE

Dimensioni (mm)	<b>740 x 440</b>
Raggio Vasca (mm)	<b>10</b>
Base (mm)	<b>800</b>
Foro da incasso (mm)	<b>Semifilo 730 x 430</b>
Foro da incasso (mm)	<b>Filotop 730 x 430</b>
Foro da incasso (mm)	<b>Sottotop 700 x 400 R10</b>
Profondità Vasca (mm)	<b>200</b>
Orientamento	<b>Non reversibile</b>

Installazione miscelatore sul top

Satinata

Euro **500**

LIY700SAC

Disponibile da Giugno 2021

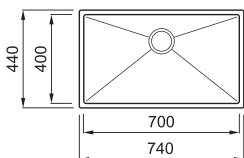

Disegno Tecnico approfondito:  
QR code a pag. 188

## ACCESSORI CONSIGLIATI



# YOGA 500

Lavello 1 vasca



**NEW**



## CARATTERISTICHE

Dimensioni (mm)	<b>540 x 440</b>
Raggio Vasca (mm)	<b>10</b>
Base (mm)	<b>600</b>
Foro da incasso (mm)	<b>Semifilo 530 x 430</b>
Foro da incasso (mm)	<b>Filotop 530 x 430</b>
Foro da incasso (mm)	<b>Sottotop 500 x 400 R10</b>
Profondità Vasca (mm)	<b>200</b>
Orientamento	<b>Non reversibile</b>

Installazione miscelatore sul top

Satinata

Euro **407**

LIY500SAC

Disponibile da Giugno 2021

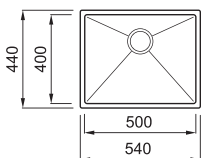

Disegno Tecnico approfondito:  
QR code a pag. 188

## ACCESSORI CONSIGLIATI

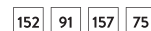

# ACCESSORI LAVELLI INOX

## COLLEZIONI W-SQUARE / YOGA R10 / CUBE R10 / SKY

91 Element  
Tagliere 420



ATH040OL  
Euro **113**  
Pag. 177

152 Element  
Colander 418



AVP035BK  
Euro **60**  
Pag. 181

157 Element Rollmat 440

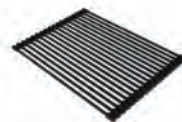

ARS013BK  
Euro **74**  
Pag. 182

75 Cestello



ACI01307  
Euro **93**  
Pag. 186

88 Element Tagliere  
Sliding 50cm



ATH010QU  
Euro **136**  
Pag. 176

156 Element Rollmat 500

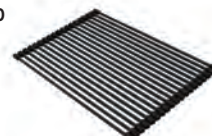

ARS023BK  
Euro **82**  
Pag. 181

## COLLEZIONE SKY (Escluso Sky Round 435)

## CUBE 750 2V

Lavello 2 vasche



NEW



### CARATTERISTICHE

Dimensioni (mm)	750 x 510
Raggio Vasca (mm)	10
Base (mm)	800
Foro da incasso (mm)	Semifilo 740 x 500
Foro da incasso (mm)	Filotop 740 x 500
Profondità Vasca (mm)	200
Orientamento	Non reversibile

Disponibile da Giugno 2021

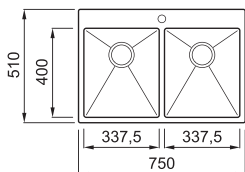

Disegno Tecnico approfondito:  
QR code a pag. 188

Dotato di Banco Rubinetteria integrato

Satinata

Euro 587

LIU750SAC

ACCESSORI CONSIGLIATI

152 91 157 75

## CUBE 700

Lavello 1 vasca



NEW



### CARATTERISTICHE

Dimensioni (mm)	750 x 510
Raggio Vasca (mm)	10
Base (mm)	800
Foro da incasso (mm)	Semifilo 740 x 500
Foro da incasso (mm)	Filotop 740 x 500
Profondità Vasca (mm)	200
Orientamento	Non reversibile

Disponibile da Giugno 2021

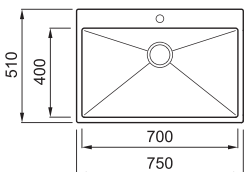

Disegno Tecnico approfondito:  
QR code a pag. 188

Dotato di Banco Rubinetteria integrato

Satinata

Euro 519

LIU700SAC

ACCESSORI CONSIGLIATI

152 91 157 75

## CUBE 500

Lavello 1 vasca



NEW



### CARATTERISTICHE

Dimensioni (mm)	550 x 510
Raggio Vasca (mm)	10
Base (mm)	600
Foro da incasso (mm)	Semifilo 540 x 500
Foro da incasso (mm)	Filotop 540 x 500
Profondità Vasca (mm)	200
Orientamento	Non reversibile

Disponibile da Giugno 2021

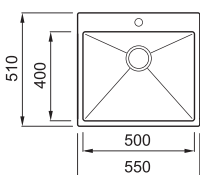

Disegno Tecnico approfondito:  
QR code a pag. 188

Dotato di Banco Rubinetteria integrato

Satinata

Euro 425

LIU500SAC

ACCESSORI CONSIGLIATI

152 91 157 75

## SKY 500

Lavello 2 vasche con gocciolatoio

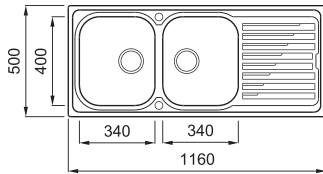

Disegno Tecnico approfondito: QR code a pag. 188



### CARATTERISTICHE

Dimensioni (mm)	1160 x 500
Base (mm)	800
Foro da incasso (mm)	1140 x 480
Profondità Vasca 1 (mm)	180
Profondità Vasca 2 (mm)	180
Orientamento	Non reversibile

Satinata - Vasca a Destra

Satinata - Vasca a Sinistra

Euro 274

Euro 274

LIK500SACDX

LIK500SAC SX

### ACCESSORI CONSIGLIATI

156 88 152 30

## SKY 480

Lavello 1 vasca con gocciolatoio

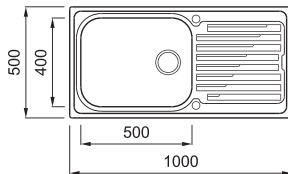

Disegno Tecnico approfondito: QR code a pag. 188



### CARATTERISTICHE

Dimensioni (mm)	1000 x 500
Base (mm)	600
Foro da incasso (mm)	980 x 480
Profondità Vasca (mm)	205
Orientamento	Non reversibile

Satinata - Vasca a Destra

Satinata - Vasca a Sinistra

Euro 265

Euro 265

LIK480SACDX

LIK480SAC SX

### ACCESSORI CONSIGLIATI

156 88 152 30

## SKY 450

Lavello 2 vasche

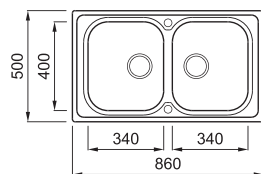

Disegno Tecnico approfondito: QR code a pag. 188



### CARATTERISTICHE

Dimensioni (mm)	860 x 500
Base (mm)	800
- se inizio composizione	900
Foro da incasso (mm)	840 x 480
Profondità Vasca 1 (mm)	180
Profondità Vasca 2 (mm)	180
Orientamento	Reversibile

Satinata

Euro 247

LIK450SAC

### ACCESSORI CONSIGLIATI

156 88 152 30

## SKY 400

Lavello 1 vasca con gocciolatoio

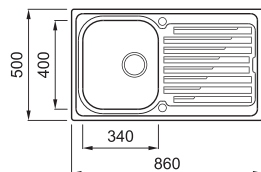

Disegno Tecnico approfondito: QR code a pag. 188



### CARATTERISTICHE

Dimensioni (mm)	860 x 500
Base (mm)	450
Foro da incasso (mm)	840 x 480
Profondità Vasca (mm)	180
Orientamento	Non reversibile

Satinata - Vasca a Destra

Satinata - Vasca a Sinistra

Euro 203

Euro 203

LIK400SACDX

LIK400SAC SX

### ACCESSORI CONSIGLIATI

156 88 152 30



## SKY 360

Lavello 1 vasca

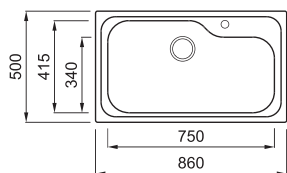

Disegno Tecnico approfondito: QR code a pag. 188



### CARATTERISTICHE

Dimensioni (mm)	<b>860 x 500</b>
Base (mm)	<b>900</b>
Foro da incasso (mm)	<b>840 x 480</b>
Profondità Vasca (mm)	<b>190</b>
Orientamento	<b>Non reversibile</b>

Satinata

Euro **330**

LIX360SAC

### ACCESSORI CONSIGLIATI

156 88 46 47 48 49

## SKY 125

Lavello 1 vasca con gocciolatoio

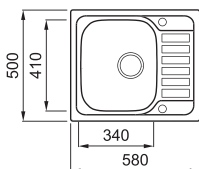

Disegno Tecnico approfondito: QR code a pag. 188



### CARATTERISTICHE

Dimensioni (mm)	<b>580 x 500</b>
Base (mm)	<b>450</b>
Foro da incasso (mm)	<b>560 x 480</b>
Profondità Vasca (mm)	<b>170</b>
Orientamento	<b>Non reversibile</b>

Satinata - Vasca a Destra

Euro **109**

LIX125SACDX

Satinata - Vasca a Sinistra

Euro **109**

LIX125SACSX

### ACCESSORI CONSIGLIATI

156 88 30

## SKY ROUND 435

Lavello 1 vasca

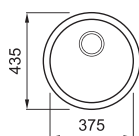

Disegno Tecnico approfondito: QR code a pag. 188



### CARATTERISTICHE

Dimensioni (mm)	<b>ø 435</b>
Base (mm)	<b>450</b>
Foro da incasso (mm)	<b>ø 415</b>
Profondità Vasca (mm)	<b>160</b>
Orientamento	<b>Non reversibile</b>

Satinata

Euro **101**

LIKROUSAC

### ACCESSORI CONSIGLIATI

15

## SKY CORNER

Lavello angolare 2 vasche con gocciolatoio

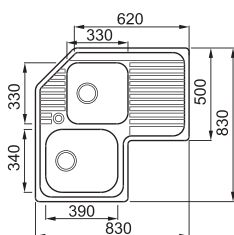

Disegno Tecnico approfondito: QR code a pag. 188



### CARATTERISTICHE

Dimensioni (mm)	<b>830 x 830</b>
Base (mm)	<b>Angolare da disegno</b>
Foro da incasso (mm)	<b>210</b>
Profondità Vasca 1 (mm)	<b>210</b>
Profondità Vasca 2 (mm)	<b>200</b>
Orientamento	<b>Non reversibile</b>

Satinata - Vasca a Destra

Euro **685**

LIXCORSA CDX

Satinata - Vasca a Sinistra

Euro **685**

LIXCORSA CSX

### ACCESSORI CONSIGLIATI

156 88 30

COLLEZIONE

# MISCELATORI

2 ANNI - YEARS  
WARRANTY  
GARANTITO

## UNA SCELTA DI STILE

Essere se stessi in ogni ambiente e scegliere di esprimere la propria personalità: oggi è possibile grazie alla nuova collezione di miscelatori Elleci.

Nuove forme, tecnologie innovative, e colori sempre in armonia cromatica con i lavelli Elleci, per dar loro un tocco di personalità in più.

In gamma trovano spazio miscelatori capaci di soddisfare qualsiasi esigenza: miscelatori di design, miscelatori con doccette estraibili per raggiungere facilmente ogni angolo del lavello, miscelatori reclinabili adatti per le installazioni sottofinestra. C'è solo l'imbarazzo della scelta.

## QUESTIONE DI FEELING

Un ambiente di qualità prevede la cura di ogni dettaglio. I nostri miscelatori si abbinano cromaticamente ai lavelli grazie al sapiente utilizzo del colore. Cromie uniche che rendono compatibili tra loro gli elementi della cucina, per una piacevole esperienza visiva.



## DESIGN BLACK MATT

La nuova finitura Black Matt Elleci si caratterizza per la sua capacità di interpretare tendenze stilistiche, proponendo nuovi accostamenti cromatici e valorizzando l'ambiente circostante.



## NUOVI MISCELATORI BIO

La nuova linea composta da quattro miscelatori certificati antibatterici grazie al trattamento specifico superficiale di verniciatura a ioni d'argento.



## SISTEMA FILTRANTE



Il sistema filtrante Elleci trasforma il rubinetto della tua cucina in una sorgente d'acqua fresca e depurata. Un miscelatore con sistema filtrante fornisce acqua filtrata ogni volta che serve.

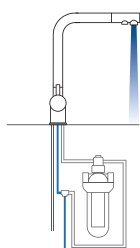

1. ACQUA FREDDA

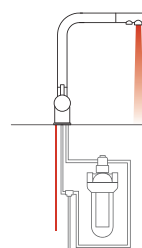

2. ACQUA CALDA

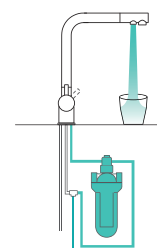

3. ACQUA DEPURATA

BIO **NEW**

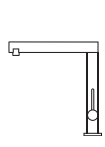

**BIO TEMA**  
PAG. 196

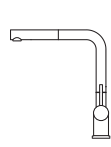

**BIO STREAM PLUS**  
PAG. 196

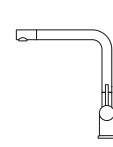

**BIO STREAM**  
PAG. 197

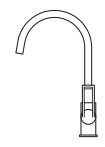

**BIO BRIDGE**  
PAG. 197

DESIGN BLACK MATT **NEW**

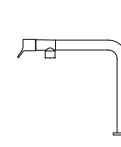

**SOLO**  
PAG. 198

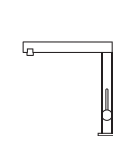

**TEMA**  
PAG. 200

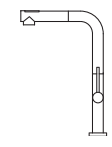

**FLUX**  
PAG. 202

DESIGN



**FLAT**  
PAG. 204



**BLADE**  
PAG. 204

PROFESSIONAL

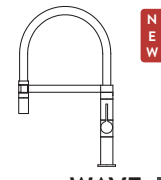

**WAVE**  
PAG. 206

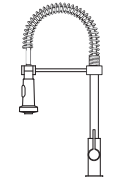

**LENA**  
PAG. 208

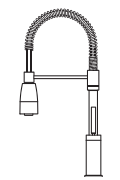

**CHEF**  
PAG. 208

FILTRANTE

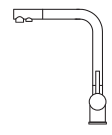

**TOURMALINE**  
PAG. 210

RECLINABILI

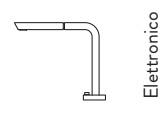

**INVISIO**  
PAG. 212

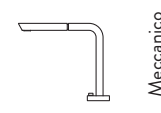

**INVISIO**  
PAG. 212



**FUSION**  
PAG. 213

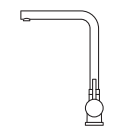

**DANUBIO**  
PAG. 213

MODERN CANNA L



**ARES**  
PAG. 214

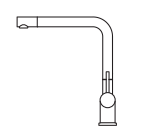

**STREAM**  
PAG. 214

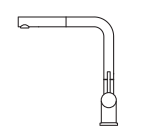

**STREAM PLUS**  
PAG. 215

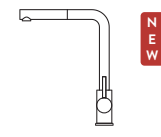

**TRAIL PLUS**  
PAG. 216

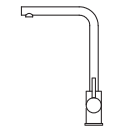

**TRAIL**  
PAG. 216

MODERN CANNA CURVA

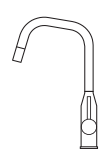

**DORA PLUS**  
PAG. 218

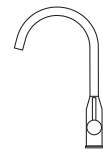

**ADIGE**  
PAG. 218



**VOLTA**  
PAG. 220



**ATHENA**  
PAG. 220



**BRIDGE**  
PAG. 222

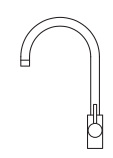

**CLOUD**  
PAG. 222

COUNTRY

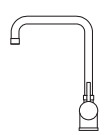

**SENNA**  
PAG. 224

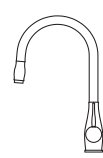

**NEVA**  
PAG. 224

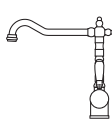

**RIO**  
PAG. 226



**ELBA**  
PAG. 226



**PO**  
PAG. 227

BASIC

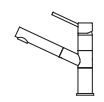

**RENO**  
PAG. 228

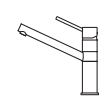

**SAVA**  
PAG. 228



**VENERE**  
PAG. 230

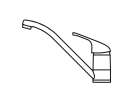

**MINERVA**  
PAG. 231



**MINERVA 35**  
PAG. 231

MISCELATORI



# BIO TEMA

Miscelatore con **trattamento antibatterico**, monocomando con canna girevole

NEW

## CARATTERISTICHE

Dimensioni Foro (ømm) 35  
Base (mm) 50  
Rotazione Canna 360°  
Flessibile  
Cartuccia (ømm) 25

## COLORI ABBINABILI

**KERATEK** plus  
CERAMIC NANOTECHNOLOGY CINE Euro 534  
● K86 Black MKKTEM86AB

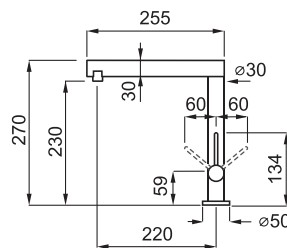

# BIO STREAM PLUS

Miscelatore con **trattamento antibatterico**, monocomando con canna girevole e doccetta estraibile

NEW

## CARATTERISTICHE

Dimensioni Foro (ømm) 35  
Base (mm) 50  
Rotazione Canna 360°  
Flessibile  
Cartuccia (ømm) 35

## COLORI ABBINABILI

**KERATEK** plus  
CERAMIC NANOTECHNOLOGY CINE Euro 404  
● K86 Black MKKSTP86AB

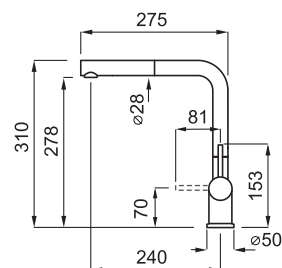

# BIO STREAM

Miscelatore con **trattamento antibatterico**, monocomando con canna girevole

NEW



## CARATTERISTICHE

Dimensioni Foro (ømm) 35  
Base (mm) 50  
Rotazione Canna 360°  
Flessibile  
Cartuccia (ømm) 35

## COLORI ABBINABILI

**KERATEK** plus  
CERAMIC NANOTECHNOLOGY CN6

Euro 356

● K86 Black

MKKSTR86AB

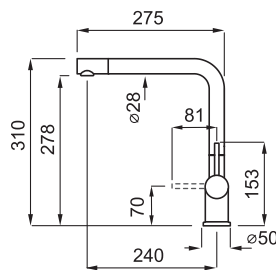

MISCELATORI

# BIO BRIDGE

Miscelatore con **trattamento antibatterico**, monocomando con canna girevole

NEW



## CARATTERISTICHE

Dimensioni Foro (ømm) 35  
Base (mm) 50  
Rotazione Canna 360°  
Flessibile  
Cartuccia (ømm) 35

## COLORI ABBINABILI

**KERATEK** plus  
CERAMIC NANOTECHNOLOGY CN6

Euro 284

● K86 Black

MKKBRI86AB

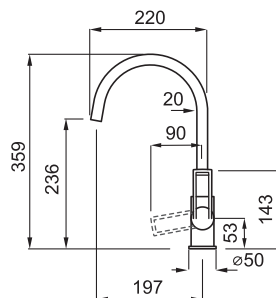

# SOLO

Miscelatore monocomando con canna girevole

NEW

## CARATTERISTICHE

Dimensioni Foro (ømm) 35

Base (mm) 50

Rotazione Canna 90°

Flessibile

Cartuccia (ømm) 25

35

50

90°

Inox 3/8"

25

## COLORI ABBINABILI

**BLACK MATT**

Euro 620



BK Black Matt

MOKSOLBK

**CROMATO**

Euro 540



CR Cromato

MIKSOLCR

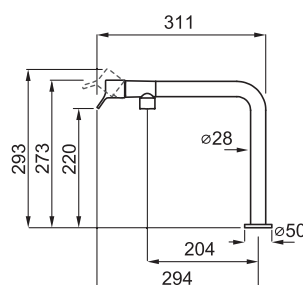



Miscelatore: Solo BK Black Matt  
Lavello: Best 360 K86 Black



# TEMA

Miscelatore monocomando con canna girevole

NEW

## CARATTERISTICHE

Dimensioni Foro (ømm) 35  
Base (mm) 50  
Rotazione Canna 360°  
Flessibile  
Cartuccia (ømm) 25

35  
50  
360°  
Inox 3/8"  
25

## COLORI ABBINABILI

CROMATO		Euro 460
● CR Cromato		MIKTEMCR
<b>KERATEK<sup>Plus</sup></b> <small>CERAMIC NANOTECHNOLOGY ONE</small>		Euro 510
● K99 Dark Grey		MKKTEM99
● K97 Light Grey		MKKTEM97
● K96 White		MKKTEM96
● K95 Champagne		MKKTEM95
● K93 Dove Grey		MKKTEM93
● K86 Black		MKKTEM86

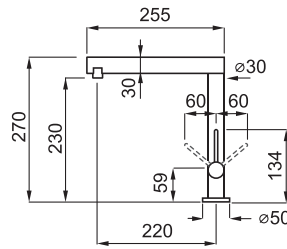

Miscelatore: Tema BK Black Matt  
Lavello: Best 360 K86 Black





# FLUX

Miscelatore monocomando con canna girevole e doccetta con cambio getto

**NEW**

## CARATTERISTICHE

Dimensioni Foro (ømm) 35  
Base (mm) 50  
Rotazione Canna 360°  
Flessibile  
Cartuccia (ømm) 25



## COLORI ABBINABILI

- BLACK MATT** Euro 420  
● BK Black Matt MOKFLUBK
- CROMATO** Euro 380  
● CR Cromato MIKFLUCR

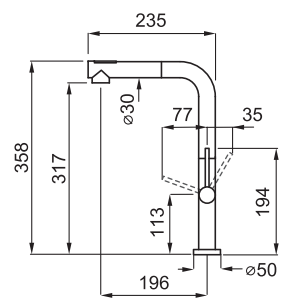

Miscelatore: Flux BK Black Matt  
Lavello: Best 360 K86 Black



MISCELATORI



# FLAT

Miscelatore monocomando con canna girevole

## CARATTERISTICHE

Dimensioni Foro (ømm) 35  
 Base (mm) 50 x 50  
 Rotazione Canna 360°  
 Flessibile  
 Cartuccia (ømm) 25

35  
 50 x 50  
 360°  
 Inox 3/8"  
 25

## COLORI ABBINABILI

**CROMATO** Euro 510  
 ● CR Cromato MIKFLACR  
**KERATEK Plus** Euro 610  
CERAMIC NANOTECHNOLOGY ONE  
 ● K96 White MKKFLA96  
 ● K86 Black MKKFLA86

**GRANITEK** Euro 610  
NATURAL GRANITE EFFECT  
**MATT**  
 ● G68 Bianco MGKFLA68  
 ● G40 Nero MGKFLA40

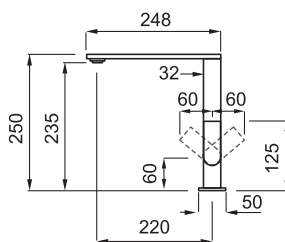

# BLADE

Miscelatore monocomando con corpo inclinato e canna girevole

## CARATTERISTICHE

Dimensioni Foro (ømm) 35  
 Base (mm) 50 x 50  
 Rotazione Canna 360°  
 Flessibile  
 Cartuccia (ømm) 25

35  
 50 x 50  
 360°  
 Inox 3/8"  
 25

## COLORI ABBINABILI

**CROMATO** Euro 476  
 ● CR Cromato MIKBLACR  
**KERATEK Plus** Euro 564  
CERAMIC NANOTECHNOLOGY ONE  
 ● K96 White MKKBLA96  
 ● K86 Black MKKBLA86

**GRANITEK** Euro 564  
NATURAL GRANITE EFFECT  
**MATT**  
 ● G68 Bianco MGKBLA68  
 ● G40 Nero MGKBLA40

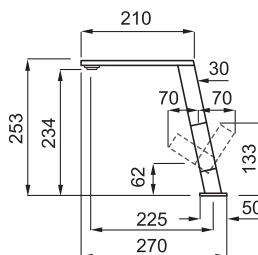



Miscelatore: **Blade K96 White**  
Lavello: **Quadra 130 K96 White**



# WAVE

Miscelatore monocomando con canna alta girevole in silicone e doccetta estraibile

**NEW**



## CARATTERISTICHE

Dimensioni Foro (ømm) 35  
Base (mm) 50  
Rotazione Canna 360°  
Flessibile  
Cartuccia (ømm) 25

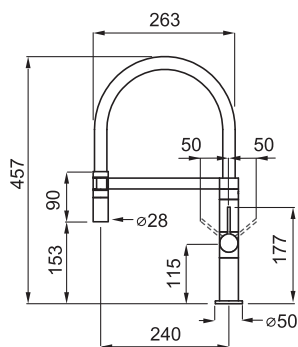

## COLORI ABBINABILI

**BLACK MATT**

Euro 330



BK Black Matt

MOKWAVBK

**CROMATO**

Euro 290



CR Cromato

MIKWAVCR





Miscelatore: Wave BK Black Matt  
Lavello: Best 360 K86 Black





# LENA

Miscelatore monocomando con canna alta girevole e doccetta con cambio getto



## CARATTERISTICHE

Dimensioni Foro (ømm) 35  
 Base (mm) 48  
 Rotazione Canna 360°  
 Flessibile  
 Cartuccia (ømm) 25



## COLORI ABBINABILI

**CROMATO**

Euro 402

● CR Cromato

MIKLENCR

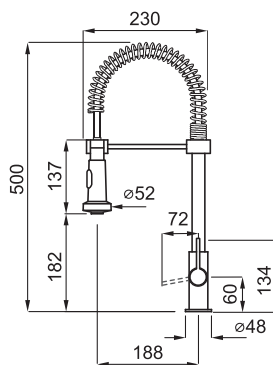

# CHEF

Miscelatore monocomando con canna alta girevole e doccetta con cambio getto



## CARATTERISTICHE

Dimensioni Foro (ømm) 35  
 Base (mm) 50  
 Rotazione Canna 360°  
 Flessibile  
 Cartuccia (ømm) 35



## COLORI ABBINABILI

**CROMATO**

Euro 325

● CR Cromato

MIKCHECR

**KERATEK** plus  
CERAMIC NANOTECHNOLOGY CMB

Euro 360

● K86 Black

MKKCHE86

**GRANITEK**  
NATURAL GRANITE EFFECT

Euro 360

MATT

● G40 Nero

MGKCHE40

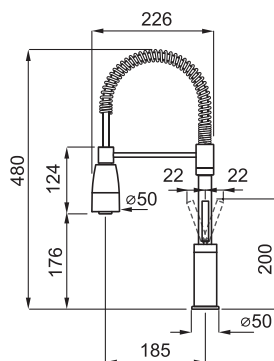

Miscelatore: **Chef K86 Black**  
Lavello: **Best 360 K86 Black**



MISCELATORI



# TOURMALINE

Miscelatore filtrante monocomando con canna girevole

## CARATTERISTICHE

Dimensioni Foro (ømm)	35
Base (mm)	50
Rotazione Canna	360°
Flessibile	Inox 3/8"
Cartuccia (ømm)	35



## COLORI ABBINABILI

**KERATEK** plus  
CERAMIC NANOTECHNOLOGY CMB

● K96 White	Euro 287
● K86 Black	MKKTOU96
	MKKTOU86

**GRANITEK**  
NATURAL GRANITE EFFECT

MATT	Euro 287
● G68 Bianco	MGKTOU68
● G40 Nero	MGKTOU40
CLASSIC	
● G51 Avena	MGKTOU51

## ACCESSORIO

**Kit Filtraggio**  
AFI01300  
Euro 142

**Ricambio Filtro**  
RFP01300  
Euro 74

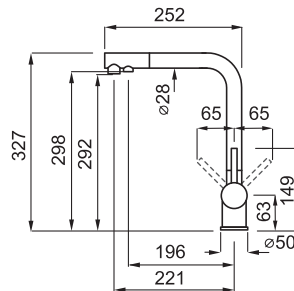



Miscelatore: **Tourmaline IN Inox**  
Lavello: **Zen 105 K93 Dove Grey**



MISCELATORI

## SISTEMA DI FILTRAGGIO

Il sistema filtrante Elleci trasforma il rubinetto della tua cucina in una sorgente d'acqua fresca e depurata. Un miscelatore con sistema filtrante riduce il contenuto di metalli pesanti, cloro e calcare presenti nell'acqua del rubinetto ed è pratico da utilizzare poiché il filtro è collegato direttamente al rubinetto dell'impianto idrico di casa e fornisce in tal modo acqua filtrata ogni volta che serve.

La cartuccia di ricambio del filtro assicura una capacità filtrante di 4.000 litri, alla portata di 2 litri al minuto e rimuoverla e sostituirla è davvero semplice.

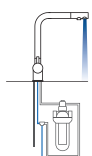

1. ACQUA FREDDA

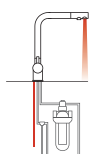

2. ACQUA CALDA

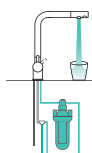

3. ACQUA DEPURATA



**INOX**

● IN Inox

Euro **287**

MIKTOUIN

**ACCESSORIO**

**Kit Filtraggio**

AFI01300

Euro **142**



**Ricambio Filtro**

RFP01300

Euro **74**



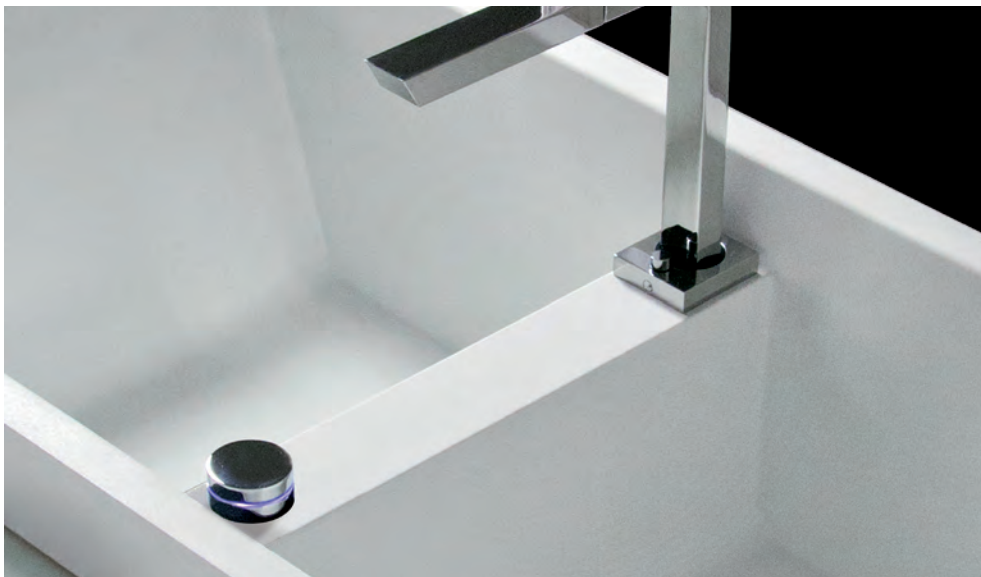

Il miscelatore Invisio Elettronico è dotato di un sofisticato ed intuitivo joystick elettronico a LED multicolor con indicazione cromatica della temperatura dell'acqua.

## INVISIO ELETTRONICO

Elettromiscelatore a scomparsa con doccetta estraibile

## INVISIO MECCANICO

Miscelatore a scomparsa con doccetta estraibile e comando remoto

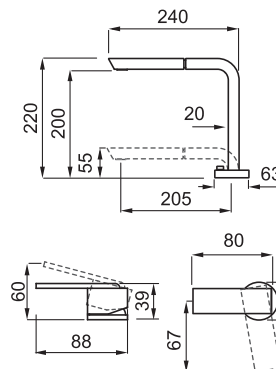
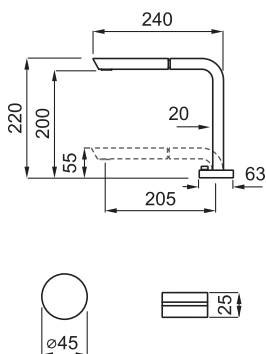

### CARATTERISTICHE

Dimensioni Foro (ømm)	<b>48</b>
Dimensioni Joystick (mm)	<b>45</b>
Dimensioni Foro Joystick (mm)	<b>13</b>
Base (mm)	<b>63 x 56</b>
Rotazione Canna	<b>360°</b>
Flessibile	<b>Inox 3/8"</b>
Cartuccia (ømm)	<b>35</b>



### CARATTERISTICHE

Dimensioni Foro (ømm)	<b>48</b>
Dimensioni Foro Leva (mm)	<b>35</b>
Base (mm)	<b>63 x 56</b>
Rotazione Canna	<b>360°</b>
Flessibile	<b>Inox 3/8"</b>
Cartuccia (ømm)	<b>35</b>



### COLORI ABBINABILI

**CROMATO** Euro **1657**  
 ● CR Cromato EIKINVCR

### COLORI ABBINABILI

**CROMATO** Euro **974**  
 ● CR Cromato MIKINVCR

# FUSION

Miscelatore a scomparsa con comando remoto

## CARATTERISTICHE

Dimensioni Foro (ømm)	38
Dimensioni Leva (mm)	52
Dimensioni Foro Leva (mm)	35
Base (mm)	52 x 52
Rotazione Canna	360°
Flessibile	Inox 3/8"
Cartuccia (ømm)	25



## COLORI ABBINABILI

### CROMATO

● CR Cromato

Euro 663

MIKFUSCR

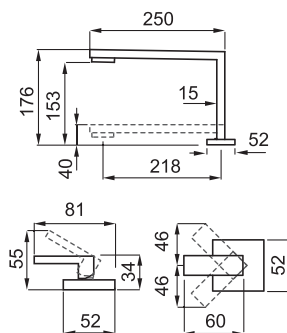

# DANUBIO

Miscelatore monocomando reclinabile con canna girevole

## CARATTERISTICHE

Dimensioni Foro (ømm)	35
Base (mm)	50
Rotazione Canna	360°
Flessibile	Inox 3/8"
Cartuccia (ømm)	40



## COLORI ABBINABILI

### CROMATO

● CR Cromato

Euro 340

MIKDANCR

**GRANITEK**  
NATURAL GRANITE EFFECT

Euro 380

### MATT

● G68 Bianco

MGKDAN68

● G40 Nero

MGKDAN40

### CLASSIC

● G51 Avena

MGKDAN51

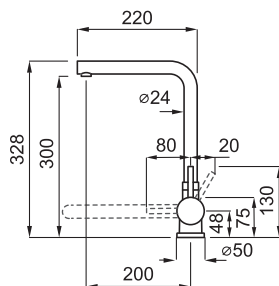



# ARES

Miscelatore monocomando con canna girevole

**NEW**



## CARATTERISTICHE

Dimensioni Foro (ømm) **35**  
 Base (mm) **45**  
 Rotazione Canna **360°**  
 Flessibile **Inox 3/8"**  
 Cartuccia (ømm) **25**

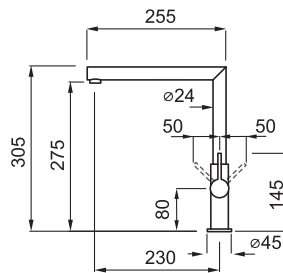

## COLORI ABBINABILI

**CROMATO** Euro **318**  
 CR Cromato MIKARECR  
**KERATEK** Plus CERAMIC NANOTECHNOLOGY ONE Euro **396**  
 K96 White MKKARE96  
 K86 Black MKKARE86

**GRANITEK** NATURAL GRANITE EFFECT Euro **396**  
**METAL**  
 M79 Aluminium MMKARE79  
 M73 Titanium MMKARE73

**GRANITEK** NATURAL GRANITE EFFECT Euro **396**  
**MATT**  
 G68 Bianco MGKARE68  
 G48 Cemento MGKARE48  
 G43 Tortora MGKARE43  
 G40 Nero MGKARE40

# STREAM

Miscelatore monocomando con canna girevole



## CARATTERISTICHE

Dimensioni Foro (ømm) **35**  
 Base (mm) **50**  
 Rotazione Canna **360°**  
 Flessibile **Inox 3/8"**  
 Cartuccia (ømm) **35**

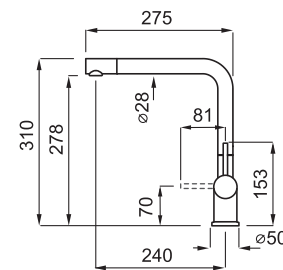

## COLORI ABBINABILI

**CROMATO** Euro **290**  
 CR Cromato MIKSTRCR  
**KERATEK** Plus CERAMIC NANOTECHNOLOGY ONE Euro **332**  
 K99 Dark Grey MKKSTR99  
 K96 White MKKSTR96  
 K86 Black MKKSTR86

**GRANITEK** NATURAL GRANITE EFFECT Euro **332**  
**METAL**  
 M79 Aluminium MMKSTR79  
 M73 Titanium MMKSTR73

**GRANITEK** NATURAL GRANITE EFFECT Euro **332**  
**MATT**  
 G68 Bianco MGKSTR68  
 G48 Cemento MGKSTR48  
 G43 Tortora MGKSTR43  
 G40 Nero MGKSTR40  
**CLASSIC**  
 G51 Avena MGKSTR51

# STREAM PLUS

Miscelatore monocomando con canna girevole e doccetta estraibile

## CARATTERISTICHE

Dimensioni Foro (ømm) 35  
 Base (mm) 50  
 Rotazione Canna 360°  
 Flessibile  
 Cartuccia (ømm) 35

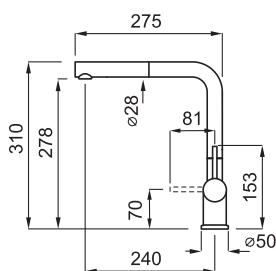

## COLORI ABBINABILI

### CROMATO

Euro **335**  
 CR Cromato MİKSTPCR

### KERATEK<sup>plus</sup>

CERAMIC NANOTECHNOLOGY ONE

Euro **380**  
 K99 Dark Grey MKKSTP99  
 K97 Light Grey MKKSTP97  
 K96 White MKKSTP96  
 K95 Champagne MKKSTP95  
 K93 Dove Grey MKKSTP93  
 K86 Black MKKSTP86

### GRANITEK

NATURAL GRANITE EFFECT

#### METAL

Euro **380**  
 M79 Aluminium MMKSTP79  
 M73 Titanium MMKSTP73

### GRANITEK

NATURAL GRANITE EFFECT

#### MATT

Euro **380**  
 G68 Bianco MGKSTP68  
 G48 Cemento MGKSTP48  
 G43 Tortora MGKSTP43  
 G40 Nero MGKSTP40

#### CLASSIC

G51 Avena MGKSTP51

Miscelatore: **Stream Plus M79 Aluminium**  
 Lavello: **Unico 410 M79 Aluminium**



# TRAIL PLUS

Miscelatore monocomando con canna girevole e doccetta estraibile

**NEW**



## CARATTERISTICHE

Dimensioni Foro (ømm) 35  
 Base (mm) 50  
 Rotazione Canna 360°  
 Flessibile  
 Cartuccia (ømm) 35

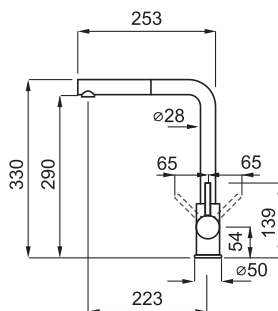

35  
 50  
 360°  
 Inox 3/8"  
 35

## COLORI ABBINABILI

- CROMATO** Euro 269
- CR Cromato MIKTRPCR
- KERATEK<sup>Plus</sup>** Euro 293  
CERAMIC NANOTECHNOLOGY ONE
- K96 White MKKTRP96
  - K86 Black MKKTRP86

**GRANITEK** Euro 293  
NATURAL GRANITE EFFECT

- METAL**
- M79 Aluminium MMKTRP79
  - M78 Espresso MMKTRP78
  - M73 Titanium MMKTRP73
  - M70 Ghisa MMKTRP70

**GRANITEK** Euro 293  
NATURAL GRANITE EFFECT

- MATT**
- G68 Bianco MGKTRP68
  - G48 Cemento MGKTRP48
  - G43 Tortora MGKTRP43
  - G40 Nero MGKTRP40
- CLASSIC**
- G62 Bianco Antico MGKTRP62
  - G59 Antracite MGKTRP59
  - G51 Avena MGKTRP51

# TRAIL

Miscelatore monocomando con canna girevole



## CARATTERISTICHE

Dimensioni Foro (ømm) 35  
 Base (mm) 50  
 Rotazione Canna 360°  
 Flessibile  
 Cartuccia (ømm) 35

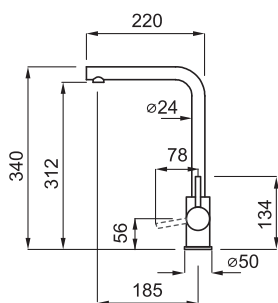

35  
 50  
 360°  
 Inox 3/8"  
 35

## COLORI ABBINABILI

- CROMATO** Euro 192
- CR Cromato MIKTRACR
- KERATEK<sup>Plus</sup>** Euro 220  
CERAMIC NANOTECHNOLOGY ONE
- K99 Dark Grey MKKTRA99
  - K97 Light Grey MKKTRA97
  - K96 White MKKTRA96
  - K95 Champagne MKKTRA95
  - K93 Dove Grey MKKTRA93
  - K86 Black MKKTRA86

**GRANITEK** Euro 220  
NATURAL GRANITE EFFECT

- METAL**
- M79 Aluminium MMKTRA79
  - M78 Espresso MMKTRA78
  - M73 Titanium MMKTRA73
  - M70 Ghisa MMKTRA70

**GRANITEK** Euro 220  
NATURAL GRANITE EFFECT

- MATT**
- G68 Bianco MGKTRA68
  - G48 Cemento MGKTRA48
  - G43 Tortora MGKTRA43
  - G40 Nero MGKTRA40
- CLASSIC**
- G62 Bianco Antico MGKTRA62
  - G59 Antracite MGKTRA59
  - G51 Avena MGKTRA51



Miscelatore: Trail Plus M73 Titanium  
Lavello: Quadra 105 Sottotop M73 Titanium



# DORA PLUS

Miscelatore monocomando con canna girevole e doccetta estraibile



## CARATTERISTICHE

Dimensioni Foro (ømm) 35  
 Base (mm) 50  
 Rotazione Canna 360°  
 Flessibile  
 Cartuccia (ømm) 35



35  
 50  
 360°  
 Inox 3/8"  
 35

## COLORI ABBINABILI

**INOX** Euro 356  
 IN Inox MIKDRPIN  
**KERATEK** Plus CERAMIC NANOTECHNOLOGY CNB Euro 356  
 K96 White MKKDRP96  
 K86 Black MKKDRP86

## GRANITEK

NATURAL GRANITE EFFECT

Euro 356

### MATT

G68 Bianco MGKDRP68  
 G40 Nero MGKDRP40

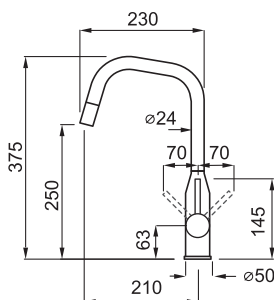

# ADIGE

Miscelatore monocomando con canna girevole



## CARATTERISTICHE

Dimensioni Foro (ømm) 35  
 Base (mm) 50  
 Rotazione Canna 360°  
 Flessibile  
 Cartuccia (ømm) 35



35  
 50  
 360°  
 Inox 3/8"  
 35

## COLORI ABBINABILI

**INOX** Euro 292  
 IN Inox MIKADIIN  
**KERATEK** Plus CERAMIC NANOTECHNOLOGY CNB Euro 292  
 K96 White MKKADI96  
 K86 Black MKKADI86

## GRANITEK

NATURAL GRANITE EFFECT

Euro 292

### MATT

G68 Bianco MGKADI68  
 G40 Nero MGKADI40

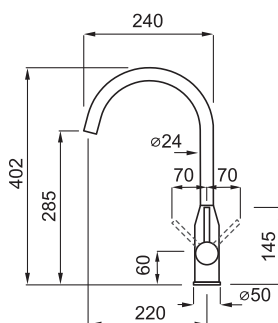

Miscelatore: Dora Plus IN Inox  
Lavello: Zen 105 K93 Dove Grey



MISCELATORI



# VOLTA

Miscelatore monocomando con canna girevole

**NEW**



## CARATTERISTICHE

Dimensioni Foro (ømm) 35  
 Base (mm) 45  
 Rotazione Canna 360°  
 Flessibile  
 Cartuccia (ømm) 25

35  
 45  
 360°  
 Inox 3/8"  
 25

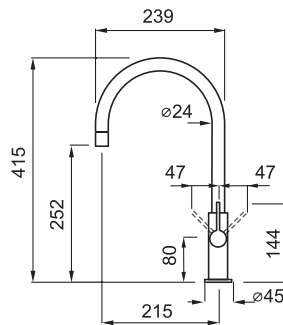

## COLORI ABBINABILI

- CROMATO** Euro 264
- CR Cromato MIKVTACR
- KERATEK** CERAMIC NANOTECHNOLOGY OMS Euro 329
- K96 White MKKVTA96
  - K86 Black MKKVTA86

**GRANITEK** NATURAL GRANITE EFFECT Euro 329

- METAL**
- M79 Aluminium MMKVTA79
  - M73 Titanium MMKVTA73

**GRANITEK** NATURAL GRANITE EFFECT Euro 329

- MATT**
- G68 Bianco MGKVTA68
  - G48 Cemento MGKVTA48
  - G43 Tortora MGKVTA43
  - G40 Nero MGKVTA40

# ATHENA

Miscelatore monocomando con canna girevole



## CARATTERISTICHE

Dimensioni Foro (ømm) 35  
 Base (mm) 48  
 Rotazione Canna 360°  
 Flessibile  
 Cartuccia (ømm) 25

35  
 48  
 360°  
 Inox 3/8"  
 25

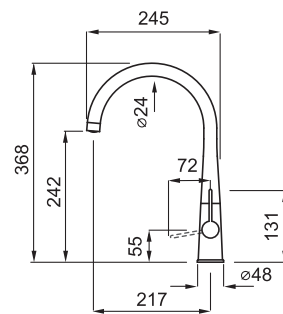

## COLORI ABBINABILI

- CROMATO** Euro 258
- CR Cromato MIKATHCR
- GRANITEK** NATURAL GRANITE EFFECT Euro 335
- METAL**
- M79 Aluminium MMKATH79
  - M73 Titanium MMKATH73

**GRANITEK** NATURAL GRANITE EFFECT Euro 335

- MATT**
- G68 Bianco MGKATH68
  - G48 Cemento MGKATH48
  - G43 Tortora MGKATH43
  - G40 Nero MGKATH40

Miscelatore: **Athena M79 Aluminium**  
Lavello: **Unico 410 M79 Aluminium**



# BRIDGE

Miscelatore monocomando con canna girevole



## CARATTERISTICHE

Dimensioni Foro (ømm) 35  
 Base (mm) 50  
 Rotazione Canna 360°  
 Flessibile  
 Cartuccia (ømm) 35

35  
 50  
 360°  
 Inox 3/8"  
 35

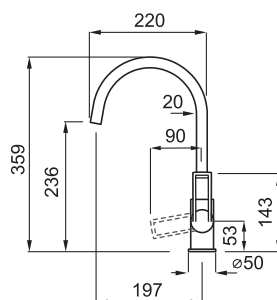

## COLORI ABBINABILI

<b>CROMATO</b>	Euro 216
● CR Cromato	MIKBRICR
<b>KERATEK<sup>plus</sup></b> CERAMIC NANOTECHNOLOGY CNE	Euro 260
● K96 White	MKKBRI96
● K86 Black	MKKBRI86

<b>GRANITEK</b> NATURAL GRANITE EFFECT	Euro 260
<b>METAL</b>	
● M79 Aluminium	MMKBRI79
● M73 Titanium	MMKBRI73

<b>GRANITEK</b> NATURAL GRANITE EFFECT	Euro 260
<b>MATT</b>	
● G68 Bianco	MGKBRI68
● G48 Cemento	MGKBRI48
● G43 Tortora	MGKBRI43
● G40 Nero	MGKBRI40
<b>CLASSIC</b>	
● G51 Avena	MGKBRI51

# CLOUD

Miscelatore monocomando con canna girevole



## CARATTERISTICHE

Dimensioni Foro (ømm) 35  
 Rotazione Canna 360°  
 Flessibile  
 Cartuccia (ømm) 35

35  
 360°  
 Inox 3/8"  
 35

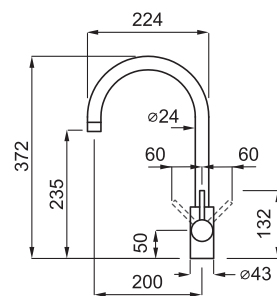

## COLORI ABBINABILI

<b>CROMATO</b>	Euro 178
● CR Cromato	MIKCLOCR
<b>KERATEK<sup>plus</sup></b> CERAMIC NANOTECHNOLOGY CNE	Euro 225
● K99 Dark Grey	MKKCLO99
● K97 Light Grey	MKKCLO97
● K96 White	MKKCLO96
● K95 Champagne	MKKCLO95
● K93 Dove Grey	MKKCLO93
● K86 Black	MKKCLO86

<b>GRANITEK</b> NATURAL GRANITE EFFECT	Euro 225
<b>METAL</b>	
● M79 Aluminium	MMKCLO79
● M78 Espresso	MMKCLO78
● M73 Titanium	MMKCLO73
● M70 Ghisa	MMKCLO70

<b>GRANITEK</b> NATURAL GRANITE EFFECT	Euro 225
<b>MATT</b>	
● G68 Bianco	MGKCLO68
● G48 Cemento	MGKCLO48
● G43 Tortora	MGKCLO43
● G40 Nero	MGKCLO40
<b>CLASSIC</b>	
● G62 Bianco Antico	MGKCLO62
● G59 Antracite	MGKCLO59
● G51 Avena	MGKCLO51



Miscelatore: **Cloud G59 Antracite**  
Lavello: **Unico 410 G59 Antracite**



# SENNA

Miscelatore monocomando con canna girevole



## CARATTERISTICHE

Dimensioni Foro (ømm) 35  
 Base (mm) 54  
 Rotazione Canna 360°  
 Flessibile  
 Cartuccia (ømm) 35

35  
 54  
 360°  
 Inox 3/8"  
 35

## COLORI ABBINABILI

- CROMATO** Euro 154  
 ● CR Cromato MIKSENCR
- GRANITEK**  
NATURAL GRANITE EFFECT Euro 196
- MATT**
- G68 Bianco MGKSEN68
  - G40 Nero MGKSEN40
- CLASSIC**
- G62 Bianco Antico MGKSEN62
  - G59 Antracite MGKSEN59
  - G55 Grigio Pietra MGKSEN55
  - G54 Nero Pietra MGKSEN54
  - G52 Bianco Pietra MGKSEN52
  - G51 Avena MGKSEN51

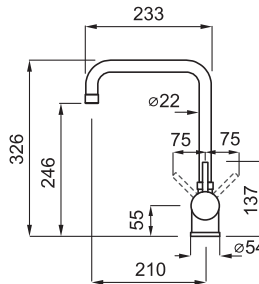

# NEVA

Miscelatore monocomando con canna girevole e doccetta estraibile



## CARATTERISTICHE

Dimensioni Foro (ømm) 35  
 Base (mm) 50  
 Rotazione Canna 360°  
 Flessibile  
 Cartuccia (ømm) 35

35  
 50  
 360°  
 Inox 3/8"  
 35

## COLORI ABBINABILI

- INOX** Euro 293  
 ● IN Inox MIKNEVIN
- OTTONE** Euro 372  
 ● OT Ottone MIKNEVOT



**GRANITEK**  
NATURAL GRANITE EFFECT Euro 293

- MATT**
- G68 Bianco MGKNEV68
  - G40 Nero MGKNEV40
- CLASSIC**
- G62 Bianco Antico MGKNEV62
  - G59 Antracite MGKNEV59
  - G51 Avena MGKNEV51

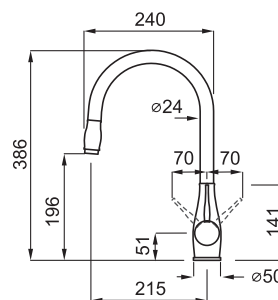

Miscelatore: Neva IN Inox  
Lavello: Zen 105 K93 Dove Grey





# RIO

Miscelatore monocomando con canna girevole

## CARATTERISTICHE

Dimensioni Foro (ømm) 35  
 Base (mm) 54  
 Rotazione Canna 360°  
 Flessibile  
 Cartuccia (ømm) 40

35  
 54  
 360°  
 Inox 3/8"  
 40

## COLORI ABBINABILI

- CROMATO** Euro 280  
 CR Cromato MIKRIOCR
- RAME** Euro 297  
 CU Rame MIKRIORA
- OTTONE** Euro 297  
 OT Ottone MIKRIOOT

**GRANITEK**  
 NATURAL GRANITE EFFECT Euro 297

- CLASSIC
- G62 Bianco Antico MGKRIO62
  - G59 Antracite MGKRIO59
  - G51 Avena MGKRIO51

## ACCESSORIO

Kit Particolari  
 Ottone Rio

AKRRIOOT  
 Euro 27

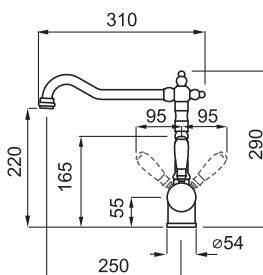

# ELBA

Miscelatore doppio comando con canna girevole

## CARATTERISTICHE

Dimensioni Foro (ømm) 35  
 Rotazione Canna 360°  
 Flessibile

35  
 360°  
 Inox 3/8"

## COLORI ABBINABILI

- CROMATO** Euro 141  
 CR Cromato MIKELBCR
- GRANITEK**  
 NATURAL GRANITE EFFECT Euro 183
- CLASSIC
- G62 Bianco Antico MGKELB62
  - G51 Avena MGKELB51

## ACCESSORIO

Kit Particolari  
 Ottone Elba

AKRELBOT  
 Euro 16

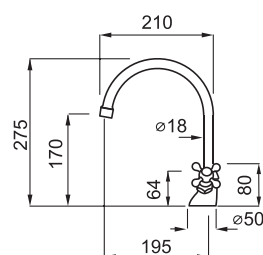

Miscelatore: Rio OT Ottone  
 Lavello: Fox 360 G51 Avena



MISCELATORI

## PO

Miscelatore monocomando con canna girevole

### CARATTERISTICHE

Dimensioni Foro (ømm) 35  
 Rotazione Canna 360°  
 Flessibile Inox 3/8"  
 Cartuccia (ømm) 40

35  
 360°  
 Inox 3/8"  
 40

### COLORI ABBINABILI

#### CROMATO

Euro 168

● CR Cromato

MIKPOCR

**GRANITEK**  
 NATURAL GRANITE EFFECT

Euro 189

#### METAL

● M79 Aluminium

MMKPO79

● M73 Titanium

MMKPO73

**GRANITEK**  
 NATURAL GRANITE EFFECT

Euro 189

#### MATT

● G68 Bianco

MGKPO68

● G40 Nero

MGKPO40

#### CLASSIC

● G62 Bianco Antico

MGKPO62

● G59 Antracite

MGKPO59

● G55 Grigio Pietra

MGKPO55

● G54 Nero Pietra

MGKPO54

● G52 Bianco Pietra

MGKPO52

● G51 Avena

MGKPO51

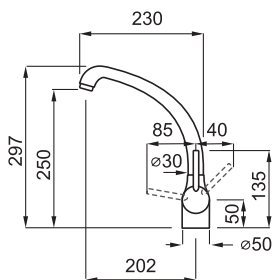

# RENO

Miscelatore monocomando con canna girevole e doccetta estraibile

## CARATTERISTICHE

Dimensioni Foro (ømm) 35  
 Base (mm) 50  
 Rotazione Canna 360°  
 Flessibile  
 Cartuccia (ømm) 35

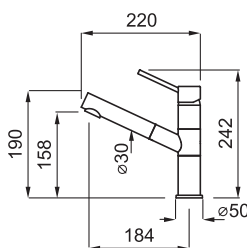

35  
 50  
 360°  
 Inox 3/8"  
 35

## COLORI ABBINABILI

### CROMATO

Euro 255

CR Cromato MIKRENCR

**KERATEK**  
CERAMIC NANOTECHNOLOGY DMS

Euro 303

K96 White MKKREN96

K86 Black MKKREN86

**GRANITEK**  
NATURAL GRANITE EFFECT

Euro 303

### METAL

M79 Aluminium MMKREN79

M78 Espresso MMKREN78

M73 Titanium MMKREN73

M70 Ghisa MMKREN70

**GRANITEK**  
NATURAL GRANITE EFFECT

Euro 303

### MATT

G68 Bianco MGKREN68

G48 Cemento MGKREN48

G43 Tortora MGKREN43

G40 Nero MGKREN40

### CLASSIC

G62 Bianco Antico MGKREN62

G59 Antracite MGKREN59

G51 Avena MGKREN51

# SAVA

Miscelatore monocomando con canna girevole

## CARATTERISTICHE

Dimensioni Foro (ømm) 35  
 Base (mm) 50  
 Rotazione Canna 360°  
 Flessibile  
 Cartuccia (ømm) 35

35  
 50  
 360°  
 Inox 3/8"  
 35

## COLORI ABBINABILI

### CROMATO

Euro 204

CR Cromato MKSAVCR

**KERATEK**  
CERAMIC NANOTECHNOLOGY DMS

Euro 248

K96 White MKKSAV96

K86 Black MKKSAV86

**GRANITEK**  
NATURAL GRANITE EFFECT

Euro 248

### METAL

M79 Aluminium MMKSAV79

M78 Espresso MMKSAV78

M73 Titanium MMKSAV73

M70 Ghisa MMKSAV70

**GRANITEK**  
NATURAL GRANITE EFFECT

Euro 248

### MATT

G68 Bianco MGKSAV68

G48 Cemento MGKSAV48

G43 Tortora MGKSAV43

G40 Nero MGKSAV40

### CLASSIC

G62 Bianco Antico MGKSAV62

G59 Antracite MGKSAV59

G51 Avena MGKSAV51

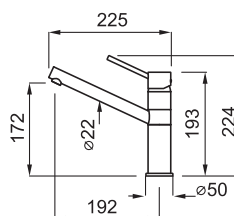



Miscelatore: Reno G51 Avena  
Lavello: Fox 360 G51 Avena



MISCELATORI



# VENERE

Miscelatore monocomando con canna girevole e doccetta estraibile con cambio getto

## CARATTERISTICHE

Dimensioni Foro (ømm) 35  
 Base (mm) 55  
 Rotazione Canna 360°  
 Flessibile  
 Cartuccia (ømm) 40



35  
 55  
 360°  
 Inox 3/8"  
 40

## COLORI ABBINABILI

- CROMATO** Euro 135
- CR Cromato MIKVENCR
- GRANITEK**  
NATURAL GRANITE EFFECT Euro 169
- METAL**
- M79 Aluminium MMKVEN79
  - M73 Titanium MMKVEN73

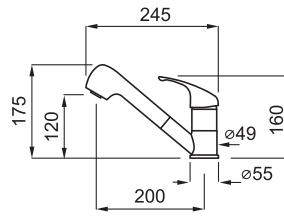

**GRANITEK**  
NATURAL GRANITE EFFECT Euro 169

- MATT**
- G68 Bianco MGKVEN68
- CLASSIC**
- G62 Bianco Antico MGKVEN62
  - G59 Antracite MGKVEN59
  - G54 Nero Pietra MGKVEN54
  - G52 Bianco Pietra MGKVEN52
  - G51 Avena MGKVEN51



# MINERVA

Miscelatore monocomando con canna girevole

## CARATTERISTICHE

Dimensioni Foro (ømm) **35**  
 Base (mm) **50**  
 Rotazione Canna **360°**  
 Flessibile **Inox 3/8"**  
 Cartuccia (ømm) **40**

## COLORI ABBINABILI

**CROMATO** Euro **92**  
 ● CR Cromato MIKMINCR  
**GRANITEK** Euro **128**  
NATURAL GRANITE EFFECT  
**METAL**  
 ● M79 Aluminium MMKMIN79  
 ● M73 Titanium MMKMIN73

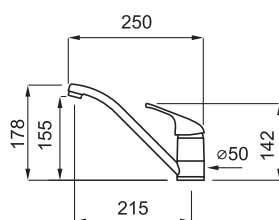

**GRANITEK** Euro **128**  
NATURAL GRANITE EFFECT  
**MATT**  
 ● G68 Bianco MGKMIN68  
 ● G40 Nero MGKMIN40  
**CLASSIC**  
 ● G62 Bianco Antico MGKMIN62  
 ● G59 Antracite MGKMIN59  
 ● G54 Nero Pietra MGKMIN54  
 ● G52 Bianco Pietra MGKMIN52  
 ● G51 Avena MGKMIN51

# MINERVA 35

Miscelatore monocomando con canna girevole

## CARATTERISTICHE

Dimensioni Foro (ømm) **35**  
 Base (mm) **47**  
 Rotazione Canna **360°**  
 Flessibile **Inox 3/8"**  
 Cartuccia (ømm) **35**

## COLORI ABBINABILI

**CROMATO** Euro **72**  
 ● CR Cromato MIK35CR  
**GRANITEK** Euro **90**  
NATURAL GRANITE EFFECT  
**MATT**  
 ● G68 Bianco MGKM3568  
 ● G40 Nero MGKM3540  
**CLASSIC**  
 ● G51 Avena MGKM3551

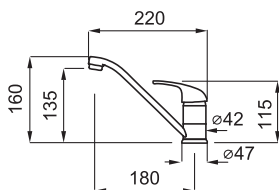



SUITE

# LEAF BLACK



Elettrodomestici  
abbinabili al colore



K86 BLACK

FORNI

## LEAF TOUCH

PAG. 242



NEW

## LEAF PLUS

PAG. 243



NEW

## LEAF

PAG. 244



NEW

PIANI INDUZIONE

## LEAF INDUCTION 80

PAG. 252



## LEAF INDUCTION 60

PAG. 252



## LEAF INDUCTION 30

PAG. 253



L'eleganza intramontabile del vetro nero è il tratto caratterizzante di tutti gli elettrodomestici della Suite LEAF BLACK. I forni si abbinano perfettamente con i performanti piani a induzione, così come con i piani Gas on Glass dove le griglie in ghisa esaltano l'accoppiamento estetico con la scocca in cristallo temperato. Completano la suite le due cappe aspiranti, tra cui la Vertical spicca per l'accoppiata vetro nero opaco e lucido.

#### PIANI A GAS

### LEAF GAS ON GLASS 70

PAG. 254



### LEAF GAS ON GLASS 60

PAG. 255



#### CAPPE

### LEAF VERTICAL

PAG. 268



### LEAF BOX

PAG. 268



SUITE

# LEAF WHITE



Elettrodomestici  
abbinabili al colore



K96 WHITE

FORNI

## LEAF TOUCH

Pag. 242



NEW

PIANI INDUZIONE

## LEAF INDUCTION 80

Pag. 252



## LEAF INDUCTION 60

Pag. 252





Il vetro bianco è l'indiscusso protagonista degli elettrodomestici della Suite LEAF WHITE, e conferisce un aspetto molto luminoso e raffinato all'ambiente cucina. Il forno Leaf Touch si abbina perfettamente con i piani a induzione, e con i piani Gas on Glass dove si esalta l'accoppiamento estetico con la scocca in cristallo temperato. Completano la suite le due cappe aspiranti, tra cui la Vertical spicca per l'accoppiata vetro bianco opaco e lucido.

#### PIANI A GAS

### LEAF GAS ON GLASS 90

Pag. 254



### LEAF GAS ON GLASS 70

Pag. 254



### LEAF GAS ON GLASS 60

Pag. 255



#### CAPPE

### LEAF VERTICAL

Pag. 268



### LEAF BOX

Pag. 268



SUITE

# PLANO

Elettrodomestici  
abbinabili al colore

FORNI

## PLANO TOUCH

Pag. 245



NEW

- K86
- G40
- K96
- G68
- K97
- K93

## PLANO PLUS

Pag. 246



- K86
- G40
- M79
- M73
- K96
- G68
- G51
- G43
- K97
- K93
- IN

## PLANO

Pag. 247



- G40
- M79
- M73
- G68
- G51
- G43
- IN

PIANI A GAS

## PLANO PLUS 75

Pag. 256



NEW

- K86
- G40
- K96
- G68
- K97
- K93

## PLANO 90

Pag. 262



- G40
- G68

## FORNO MICROONDE

Pag. 249



- K86
- G40
- M79
- M73
- K96
- G68
- G51
- G43
- K97
- K93
- IN

La Suite Plano è la più versatile e offre infinite possibilità di combinare i diversi elettrodomestici, con la certezza di avere sempre un ideale abbinamento cromatico tra loro e con i lavelli Elleci. La consueta cura del dettaglio è testimoniata dai processi tecnici di verniciatura e smaltatura degli elementi metallici, creando family feeling. Inoltre, nella Suite Plano, spiccano le due novità di prodotto: il Forno Plano Touch, classe A+ e cavità di 78 litri e il Piano Cottura Plano Plus 75, caratterizzato dai bruciatori Flat Burner e dal sistema Flame Step Control, che permette di poter regolare con precisione 9 livelli di potenza della fiamma.

PIANI A GAS

## PLANO 75

Pag. 258



- G40
- M79
- M73
- G68
- G51
- G43
- IN

## PLANO 60

Pag. 260



- G40
- M79
- M73
- G68
- G51
- G43
- IN

CAPPE

## BRIO

Pag. 269



NEW

BK

## URBAN

Pag. 269



NEW

BK



# SUITE STYLE

Elettrodomestici  
abbinabili al colore

FORNI

## STYLE

Pag. 248



NEW

G68

G51

G59

G48

PIANI A GAS

## STYLE 90

Pag. 263



G51

## FORNO MICROONDE

Pag.



G68

G51

G59

G48

Le cucine dall'estetica classica e country, caratterizzate da colori caldi ed accoglienti e dalla presenza del legno, sono l'ambiente ideale per accogliere gli elettrodomestici della Suite Style. Anche in questo caso, il processo tecnico di verniciatura e smaltatura degli elementi metallici dimostra la cura di Elleci nel creare il corretto bilanciamento cromatico.

PIANI A GAS

## STYLE 75

Pag. 264



NEW

- G68
- G51
- G59
- G48

## STYLE 60

Pag. 266



NEW

- G68
- G51
- G59
- G48

CAPPE

## BRIO

Pag. 269



NEW

BK

## URBAN

Pag. 269



NEW

BK

# FORNI

---





## DISPLAY IMAGO



Con il display IMAGO è semplice impostare e visualizzare funzione, temperatura e tempo di cottura. Il controllo elettronico permette la massima precisione nel raggiungere e mantenere la temperatura impostata.

## DISPLAY LED



Tutti i tempi, le funzioni e le temperature di cottura sono riassunte nel comodo e pratico display led e le impostazioni avvengono con estrema semplicità attraverso le manopole. La temperatura selezionata è raggiunta e mantenuta grazie al controllo elettronico.

## CAVITÀ XL



Con la sua generosa capacità interna, la cavità del forno offre il 35% di spazio in più rispetto a un forno tradizionale, mantenendo le stesse dimensioni esterne.

## STEAM CLEAN



La funzione Steam Clean sfrutta l'azione del vapore per rimuovere con facilità i residui di grasso dal forno.

## GUIDA TELESCOPICA ESTRAIBILE



Per ottimizzare l'utilizzo del forno, la guida telescopica permette di inserire ed estrarre la teglia con maggiore facilità. Questo accorgimento garantisce la massima sicurezza, evitando l'inserimento della mano nel forno.

Per ottimizzare l'utilizzo del forno, la guida telescopica permette di inserire ed estrarre la teglia

## COLD DOOR



Il calore viene trattenuto all'interno del forno, grazie all'eccellente sistema di raffreddamento interno. La temperatura della porta diminuisce evitando possibili scottature e il calore prodotto viene così sfruttato totalmente per la cottura.

Il calore viene trattenuto all'interno del forno, grazie all'eccellente sistema di raffreddamento interno. La

## VETRO PORTA REMOVIBILE



La superficie completamente liscia e senza viti, facilita la rimozione dello sporco, ed il vetro della controporta è facilmente rimovibile per consentire una pulizia più efficace e veloce, senza rimuovere l'intera controporta.

# MICROONDE

## CAVITÀ INTERNA IN ACCIAIO INOSSIDABILE



L'ampia cavità in acciaio inossidabile da 28 litri permette di alloggiare un piatto girevole da 315 mm di diametro, lo spazio ideale per ogni tipo di ricetta.

## 10 MENÙ AUTOMATICI DI COTTURA



10 menù automatici di cottura a tua disposizione, semplicemente ruotando la manopola principale. La fantasia non ha davvero più limiti: pizza, pasta, carne, pesce, verdure.

# LEAF TOUCH



**NEW**

CLASSE  
**A+**

**78**  
LITRI

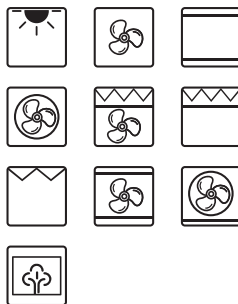

## Forno elettrico multifunzione 10 Funzioni

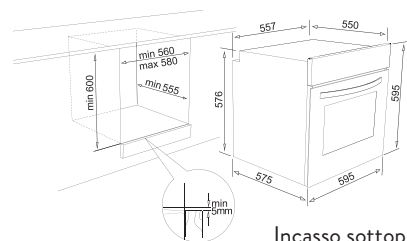

Incasso sottopiano

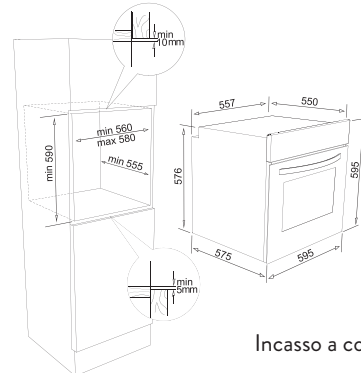

Incasso a colonna

### CARATTERISTICHE

Dimensioni (mm)	<b>595 x 595 x 575</b>
Incasso a colonna (mm)	<b>da disegno</b>
Incasso sottopiano (mm)	<b>da disegno</b>
Profondità porta aperta (mm)	<b>480</b>
Carico elettrico totale (Watt)	<b>2300</b>
Tensione (v)	<b>220</b>
Lunghezza cavo alimentazione (mm)	<b>150</b>

### ESTETICA FORNO IN VETRO ABBINABILE AI COLORI

**KERATEK** plus  
CERAMIC NANOTECHNOLOGY CNB

Euro **998**

● K96 White

FKVQ60296NS

● K86 Black

FKVQ60286NS

### SPECIFICHE

- Classe Energetica A+
- Vano cottura XL 78 Litri
- Programmatore elettronico con Display Led IMAGO
- Funzione pulizia Steam Clean
- Ventilazione radiale di raffreddamento porta
- Controporta full vetro con vetro removibile
- Cavità con smalto Easy Clean
- Manopole flat e maniglia silver
- Temperatura massima 275°C

**Dotazione:** Griglia con guida telescopica, leccarda e recipiente per funzione Steam Clean.

#### DISPLAY IMAGO



Con il display IMAGO è semplice impostare e visualizzare funzione, temperatura e tempo di cottura. Il controllo elettronico permette la massima precisione nel raggiungere e mantenere la temperatura impostata.

#### CAVITÀ XL



Con i suoi 78 litri di capacità interna, la cavità del forno offre il 30% di spazio in più rispetto a un forno tradizionale, mantenendo le stesse dimensioni esterne.

#### STEAM CLEAN



La funzione Steam Clean sfrutta l'azione del vapore per rimuovere con facilità i residui di grasso dal forno.

#### GUIDA TELESCOPICA ESTRAIBILE



Per ottimizzare l'utilizzo del forno, la guida telescopica permette di inserire ed estrarre la teglia con maggiore facilità. Questo accorgimento garantisce la massima sicurezza, evitando l'inserimento della mano nel forno.

#### COLD DOOR



Il calore viene trattenuto all'interno del forno, grazie all'eccellente sistema di raffreddamento interno. La temperatura della porta diminuisce evitando possibili scottature e il calore prodotto viene così sfruttato totalmente per la cottura.

#### VETRO PORTA REMOVIBILE



La superficie completamente liscia e senza viti, facilita la rimozione dello sporco, ed il vetro della controporta è facilmente removibile per consentire una pulizia più efficace e veloce, senza rimuovere l'intera controporta.

# LEAF PLUS



**NEW**

CLASSE **A+** **78** LITRI

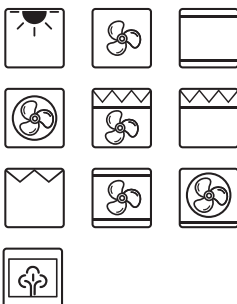

## Forno elettrico multifunzione 10 Funzioni

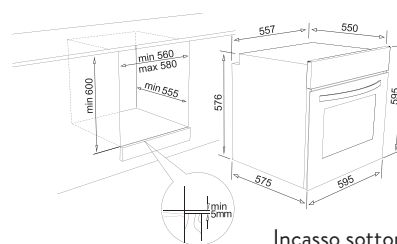

Incasso sottopiano

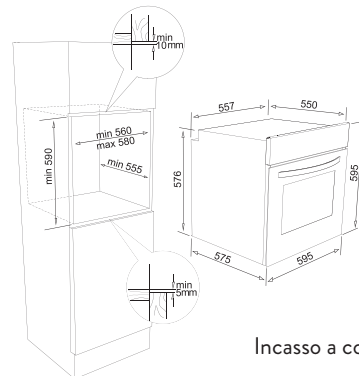

Incasso a colonna

### CARATTERISTICHE

Dimensioni (mm)	<b>595 x 595 x 575</b>
Incasso a colonna (mm)	<b>da disegno</b>
Incasso sottopiano (mm)	<b>da disegno</b>
Profondità porta aperta (mm)	<b>480</b>
Carico elettrico totale (Watt)	<b>2300</b>
Tensione (v)	<b>220</b>
Lunghezza cavo alimentazione (mm)	<b>150</b>

### ESTETICA FORNO IN VETRO ABBINABILE AI COLORI

**KERATEK** plus  
CERAMIC NANOTECHNOLOGY CN8

Euro **795**

● K86 Black

FKLP60286NS

### SPECIFICHE

- Classe Energetica A+
- Vano cottura XL 78 Litri
- Programmatore elettronico con Display Led
- Funzione pulizia Steam Clean
- Ventilazione radiale di raffreddamento porta
- Controporta full vetro con vetro removibile
- Cavità con smalto Easy Clean
- Manopole flat e maniglia silver
- Temperatura massima 275°C

**Dotazione:** Griglia, leccarda e recipiente per funzione Steam Clean.

#### DISPLAY LED



Tutti i tempi, le funzioni e le temperature di cottura sono riassunte nel comodo e pratico display led e le impostazioni avvengono con estrema semplicità attraverso le manopole. La temperatura selezionata è raggiunta e mantenuta grazie al controllo elettronico.

#### CAVITÀ XL



Con i suoi 78 litri di capacità interna, la cavità del forno offre il 30% di spazio in più rispetto a un forno tradizionale, mantenendo le stesse dimensioni esterne.

#### STEAM CLEAN



La funzione Steam Clean sfrutta l'azione del vapore per rimuovere con facilità i residui di grasso dal forno.

#### COLD DOOR



Il calore viene trattenuto all'interno del forno, grazie all'eccellente sistema di raffreddamento interno. La temperatura della porta diminuisce evitando possibili scottature e il calore prodotto viene così sfruttato totalmente per la cottura.

#### VETRO PORTA REMOVIBILE



La superficie completamente liscia e senza viti, facilita la rimozione dello sporco, ed il vetro della controporta è facilmente removibile per consentire una pulizia più efficace e veloce, senza rimuovere l'intera controporta.





**NEW**

CLASSE  
**A**

**73**  
LITRI

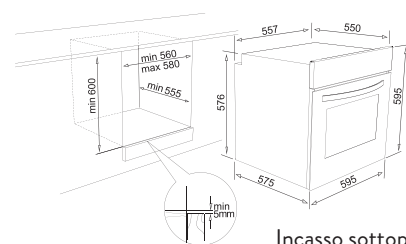
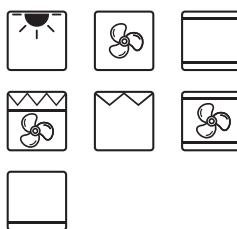

Incasso sottopiano

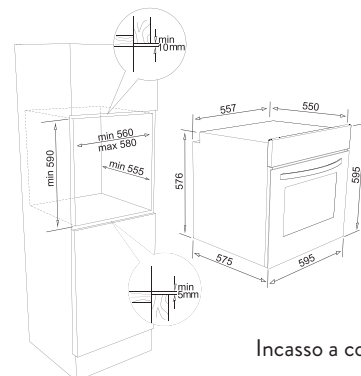

Incasso a colonna

### CARATTERISTICHE

Dimensioni (mm)	<b>595 x 595 x 575</b>
Incasso a colonna (mm)	<b>da disegno</b>
Incasso sottopiano (mm)	<b>da disegno</b>
Profondità porta aperta (mm)	<b>480</b>
Carico elettrico totale (Watt)	<b>2300</b>
Tensione (v)	<b>220</b>
Lunghezza cavo alimentazione (mm)	<b>150</b>

### SPECIFICHE

- Classe Energetica A
- Vano cottura XL 73 Litri
- Ventilazione radiale di raffreddamento porta
- Controporta full vetro con vetro removibile
- Cavità con smalto Easy Clean
- Manopole flat e maniglia silver

### ESTETICA FORNO IN VETRO ABBINABILE AI COLORI

**KERATEK** plus  
CERAMIC NANOTECHNOLOGY CMB

Euro **596**

● K86 Black

FKLE60286NS

**Dotazione:** Griglia e leccarda.

#### CAVITÀ XL



Con i suoi 78 litri di capacità interna, la cavità del forno offre il 30% di spazio in più rispetto a un forno tradizionale, mantenendo le stesse dimensioni esterne.

#### COLD DOOR



Il calore viene trattenuto all'interno del forno, grazie all'eccellente sistema di raffreddamento interno. La temperatura della porta diminuisce evitando possibili scottature e il calore prodotto viene così sfruttato totalmente per la cottura.

#### VETRO PORTA REMOVIBILE



La superficie completamente liscia e senza viti, facilita la rimozione dello sporco, ed il vetro della controporta è facilmente removibile per consentire una pulizia più efficace e veloce, senza rimuovere l'intera controporta.

# PLANO TOUCH



**NEW**

CLASSE **A+** **78** LITRI

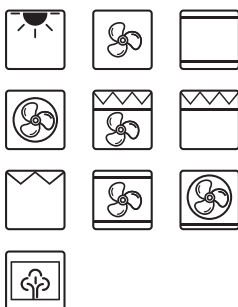

## Forno elettrico multifunzione 10 Funzioni

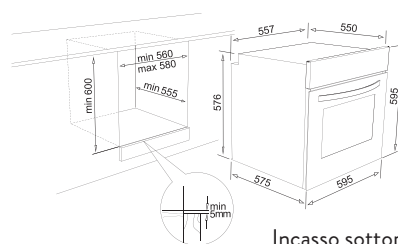

Incasso sottopiano

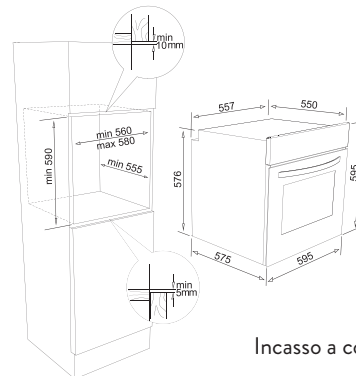

Incasso a colonna

### CARATTERISTICHE

Dimensioni (mm)	<b>595 x 595 x 575</b>
Incasso a colonna (mm)	<b>da disegno</b>
Incasso sottopiano (mm)	<b>da disegno</b>
Profondità porta aperta (mm)	<b>480</b>
Carico elettrico totale (Watt)	<b>2300</b>
Tensione (v)	<b>220</b>
Lunghezza cavo alimentazione (mm)	<b>150</b>

### ESTETICA FORNO IN VETRO CON CORNICE SMALTATA ABBINABILE AI COLORI

**KERATEK** plus CERAMIC NANOTECHNOLOGY CN8

Euro **1130**

- K97 Light Grey FKPT60297TO
- K96 White FKPT60296TO
- K93 Dove Grey FKPT60293TO
- K86 Black FKPT60286TO

**GRANITEK** NATURAL GRANITE EFFECT

Euro **1130**

MATT

- G68 Bianco FGPT60268TO
- G40 Nero FGPT60240TO

### SPECIFICHE

- Classe Energetica A+
- Vano cottura XL 78 Litri
- Programmatore elettronico con Display Led IMAGO
- Funzione pulizia Steam Clean
- Ventilazione radiale di raffreddamento porta
- Controporta full vetro con vetro removibile
- Cavità con smalto Easy Clean
- Manopole flat e maniglia silver
- Temperatura massima 275°C

**Dotazione:** Griglia con guida telescopica, leccarda e recipiente per funzione Steam Clean.

#### DISPLAY IMAGO



Con il display IMAGO è semplice impostare e visualizzare funzione, temperatura e tempo di cottura. Il controllo elettronico permette la massima precisione nel raggiungere e mantenere la temperatura impostata.

#### CAVITÀ XL



Con i suoi 78 litri di capacità interna, la cavità del forno offre il 30% di spazio in più rispetto a un forno tradizionale, mantenendo le stesse dimensioni esterne.

#### STEAM CLEAN



La funzione Steam Clean sfrutta l'azione del vapore per rimuovere con facilità i residui di grasso dal forno.

#### GUIDA TELESCOPICA ESTRAIBILE



Per ottimizzare l'utilizzo del forno, la guida telescopica permette di inserire ed estrarre la teglia con maggiore facilità. Questo accorgimento garantisce la massima sicurezza, evitando l'inserimento della mano nel forno.

#### COLD DOOR



Il calore viene trattenuto all'interno del forno, grazie all'eccellente sistema di raffreddamento interno. La temperatura della porta diminuisce evitando possibili scottature e il calore prodotto viene così sfruttato totalmente per la cottura.

#### VETRO PORTA REMOVIBILE



La superficie completamente liscia e senza viti, facilita la rimozione dello sporco, ed il vetro della controporta è facilmente removibile per consentire una pulizia più efficace e veloce, senza rimuovere l'intera controporta.

# PLANO PLUS



CLASSE  
**A+**

**78**  
LITRI

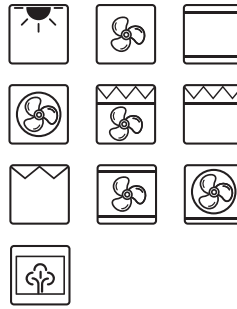

## Forno elettrico multifunzione 10 Funzioni

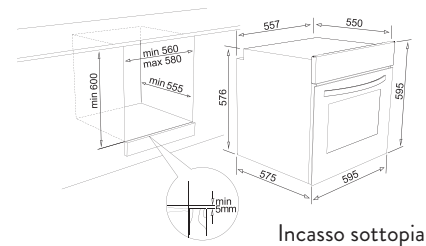

Incasso sottopiano

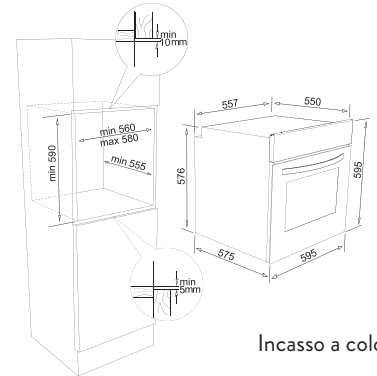

Incasso a colonna

### CARATTERISTICHE

Dimensioni (mm)	<b>595 x 595 x 575</b>
Incasso a colonna (mm)	<b>da disegno</b>
Incasso sottopiano (mm)	<b>da disegno</b>
Profondità porta aperta (mm)	<b>480</b>
Carico elettrico totale (Watt)	<b>2300</b>
Tensione (v)	<b>220</b>
Lunghezza cavo alimentazione (mm)	<b>150</b>

### SPECIFICHE

Classe Energetica A+  
Vano cottura XL 78 Litri  
Programmatore elettronico con Display Led IMAGO  
Funzione pulizia Steam Clean  
Ventilazione radiale di raffreddamento porta  
Controporta full vetro con vetro removibile  
Cavità con smalto Easy Clean  
Manopole flat e maniglia silver  
Temperatura massima 275°C

### ESTETICA FORNO IN VETRO CON CORNICE SMALTATA ABBINABILE AI COLORI

**KERATEK** plus  
CERAMIC NANOTECHNOLOGY CNB

Euro <b>862</b>	
● K97 Light Grey	FKPP60297NS
● K96 White	FKPP60296NS
● K93 Dove Grey	FKPP60293NS
● K86 Black	FKPP60286NS

**GRANITEK**  
NATURAL GRANITE EFFECT

Euro <b>862</b>	
METAL	
● M79 Aluminium	FMPP60279NS
● M73 Titanium	FMPP60273NS

**GRANITEK**  
NATURAL GRANITE EFFECT

Euro <b>862</b>	
MATT	
● G68 Bianco	FGPP60268NS
● G43 Tortora	FGPP60243NS
● G40 Nero	FGPP60240NS
CLASSIC	
● G51 Avena	FGPP60251NS

**INOX**

Euro <b>820</b>	
● IN Inox	FIPP602INNS

**Dotazione:** Griglia, leccarda e recipiente per funzione Steam Clean.

#### DISPLAY LED



Tutti i tempi, le funzioni e le temperature di cottura sono riassunte nel comodo e pratico display led e le impostazioni avvengono con estrema semplicità attraverso le manopole. La temperatura selezionata è raggiunta e mantenuta grazie al controllo elettronico.

#### CAVITÀ XL



Con i suoi 78 litri di capacità interna, la cavità del forno offre il 30% di spazio in più rispetto a un forno tradizionale, mantenendo le stesse dimensioni esterne.

#### STEAM CLEAN



La funzione Steam Clean sfrutta l'azione del vapore per rimuovere con facilità i residui di grasso dal forno.

#### COLD DOOR



Il calore viene trattenuto all'interno del forno, grazie all'eccellente sistema di raffreddamento interno. La temperatura della porta diminuisce evitando possibili scottature e il calore prodotto viene così sfruttato totalmente per la cottura.

#### VETRO PORTA REMOVIBILE



La superficie completamente liscia e senza viti, facilita la rimozione dello sporco, ed il vetro della controporta è facilmente removibile per consentire una pulizia più efficace e veloce, senza rimuovere l'intera controporta.



# PLANO



CLASSE  
**A**

**73**  
LITRI

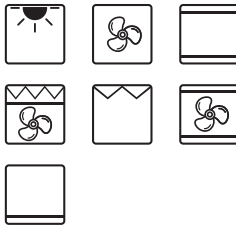

## Forno elettrico multifunzione 7 Funzioni

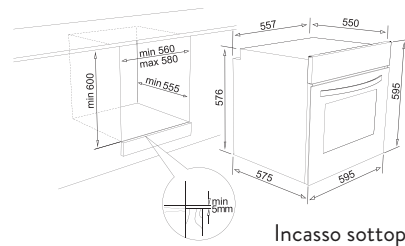

Incasso sottopiano

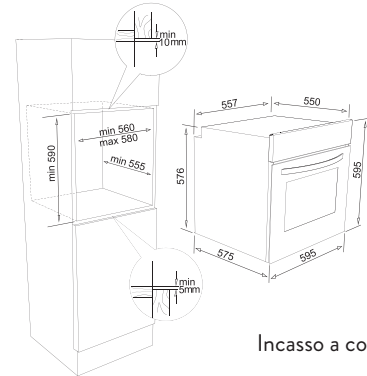

Incasso a colonna

### CARATTERISTICHE

Dimensioni (mm)	<b>595 x 595 x 575</b>
Incasso a colonna (mm)	<b>da disegno</b>
Incasso sottopiano (mm)	<b>da disegno</b>
Profondità porta aperta (mm)	<b>480</b>
Carico elettrico totale (Watt)	<b>2300</b>
Tensione (v)	<b>220</b>
Lunghezza cavo alimentazione (mm)	<b>150</b>

### SPECIFICHE

Classe Energetica A  
Vano cottura XL 73 Litri  
Ventilazione radiale di raffreddamento porta  
Controporta full vetro con vetro removibile  
Cavità con smalto Easy Clean  
Manopole flat e maniglia silver

### ESTETICA FORNO IN VETRO CON CORNICE SMALTATA ABBINABILE AI COLORI

**GRANITEK**  
NATURAL GRANITE EFFECT

Euro **696**

METAL

- M79 Aluminium FMSP60279NS
- M73 Titanium FMSP60273NS

**GRANITEK**  
NATURAL GRANITE EFFECT

Euro **696**

MATT

- G68 Bianco FGSP60268NS
  - G43 Tortora FGSP60243NS
  - G40 Nero FGSP60240NS
- CLASSIC
- G51 Avena FGSP60251NS

**INOX**

Euro **654**

- IN Inox FIAP602INNS

**Dotazione:** Griglia e leccarda.

### CAVITÀ XL



Con i suoi 73 litri di capacità interna, la cavità del forno offre il 30% di spazio in più rispetto a un forno tradizionale, mantenendo le stesse dimensioni esterne.

### COLD DOOR



Il calore viene trattenuto all'interno del forno, grazie all'eccellente sistema di raffreddamento interno. La temperatura della porta diminuisce evitando possibili scottature e il calore prodotto viene così sfruttato totalmente per la cottura.

### VETRO PORTA REMOVIBILE



La superficie completamente liscia e senza viti, facilita la rimozione dello sporco, ed il vetro della controporta è facilmente removibile per consentire una pulizia più efficace e veloce, senza rimuovere l'intera controporta.

# STYLE



**NEW**

CLASSE **A**  
**80**  
LITRI



## Forno elettrico multifunzione 6 Funzioni

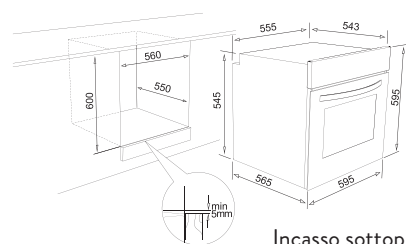

Incasso sottopiano

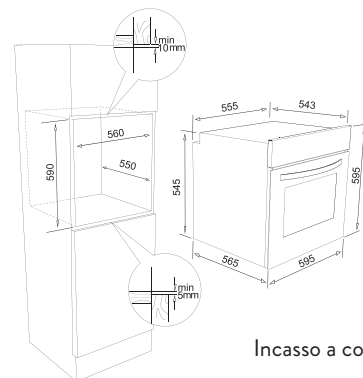

Incasso a colonna

Disponibile da **Giugno 2021**

### CARATTERISTICHE

Dimensioni (mm)	<b>595 x 595 x 565</b>
Incasso a colonna (mm)	<b>da disegno</b>
Incasso sottopiano (mm)	<b>da disegno</b>
Profondità porta aperta (mm)	<b>480</b>
Carico elettrico totale (Watt)	<b>2300</b>
Tensione (v)	<b>220</b>
Lunghezza cavo alimentazione (mm)	<b>150</b>

### ESTETICA FORNO IN VETRO CON CORNICE SMALTATA ABBINABILE AI COLORI

**GRANITEK**  
NATURAL GRANITE EFFECT

Euro **695**

MATT

- G68 Bianco FGST60368NB
- G48 Cemento FGST60348NB

CLASSIC

- G59 Antracite FGST60359NB
- G51 Avena FGST60351NB

### SPECIFICHE

- Classe Energetica A
- Vano cottura XL 80 Litri
- Ventilazione radiale di raffreddamento porta
- Controporta full vetro con vetro removibile
- Cavità con smalto Easy Clean
- Manopole flat e maniglia nere

**Dotazione:** Griglia e leccarda.

#### CAVITÀ XL



Con i suoi 80 litri di capacità interna, la cavità del forno offre il 35% di spazio in più rispetto a un forno tradizionale, mantenendo le stesse dimensioni esterne.

#### COLD DOOR



Il calore viene trattenuto all'interno del forno, grazie all'eccellente sistema di raffreddamento interno. La temperatura della porta diminuisce evitando possibili scottature e il calore prodotto viene così sfruttato totalmente per la cottura.

#### VETRO PORTA REMOVIBILE



La superficie completamente liscia e senza viti, facilita la rimozione dello sporco, ed il vetro della controporta è facilmente removibile per consentire una pulizia più efficace e veloce, senza rimuovere l'intera controporta.

# FORNO MICROONDE

Forno a microonde con grill, 10 menù automatici di cottura



**28**  
LITRI

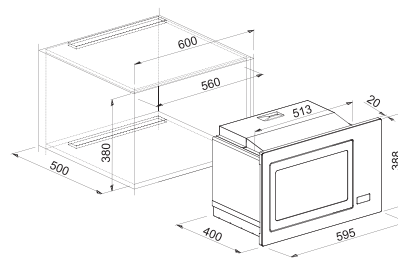

Incasso a colonna

## CARATTERISTICHE

Dimensioni (mm)	<b>595 x 388 x 400</b>
Incasso a colonna (mm)	<b>da disegno</b>
Profondità porta aperta (mm)	<b>395</b>
Carico elettrico totale (Watt)	<b>1450</b>
Tensione (v)	<b>230</b>
Lunghezza cavo alimentazione (mm)	<b>100</b>

## SPECIFICHE

- 10 menu di accesso automatico
- Scongelamento automatico in base a tempo e peso
- Programmatore elettronico con display digitale fino a 95 min.
- Pulsante di avvio rapido
- Piatto girevole ø315 mm
- Cavità interna in acciaio inossidabile
- Blocco di sicurezza

## ESTETICA FORNO IN VETRO CON CORNICE SMALTATA ABBINABILE AI COLORI

**KERATEK** plus  
CERAMIC NANOTECHNOLOGY CN8

Euro **703**

- K97 Light Grey FKSP28197WS
- K96 White FKSP28196WS
- K93 Dove Grey FKSP28193WS
- K86 Black FKSP28186WS

**GRANITEK**  
NATURAL GRANITE EFFECT

Euro **703**

MATT

- G68 Bianco FGSP28168WS
- G48 Cemento FGSP28148WS
- G43 Tortora FGSP28143WS
- G40 Nero FGSP28140WS
- CLASSIC
- G59 Antracite FGSP28159WS
- G51 Avena FGSP28151WS

INOX

Euro **601**

- IN Inox FIAP281INWS

**GRANITEK**  
NATURAL GRANITE EFFECT

Euro **703**

METAL

- M79 Aluminium FMSP28179WS
- M73 Titanium FMSP28173WS

**Dotazione:** Piatto in vetro e griglia microonde.



Il colore del forno raffigurato in questa pagina è M73 Titanium



# PIANI COTTURA

a induzione

## TIMER

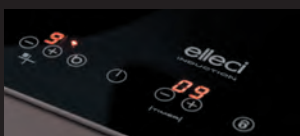

Programmazione digitale del tempo di cottura con allarme acustico configurabile su ogni singola zona del piano cottura a induzione.

## BLOCCO SICUREZZA BAMBINI



Blocco di sicurezza che può essere attivato e disattivato in qualunque momento, per bloccare tutte le funzionalità dei comandi touch.

## E-BOOST



Tempi di riscaldamento più brevi e fino al 30% in più di potenza grazie alla funzione Boost utilizzabile su ogni singola zona.

## LIMITATORE DI POTENZA



Permette di limitare l'assorbimento elettrico con 3 programmi di configurazione differenti, adattabili a tutte le esigenze casalinghe.

## EASY CLEAN

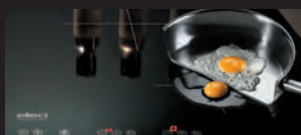

Ogni zona cottura si attiva solo al contatto con la pentola, lasciando il restante piano cottura freddo, questo fa sì che i cibi che fuoriescono non brucino e rimangano facili da pulire.

## TOUCH CONTROL PER OGNI ZONA COTTURA



Regola facilmente le impostazioni di temperatura del tuo piano cottura. Ogni zona cottura ha un proprio controllo della potenza, per offrire una chiara visualizzazione e per modificare facilmente le impostazioni della temperatura.



### FLAT BURNER



Con la loro particolare forma, i Flat Burners permettono di disperdere meno calore laterale, con migliore efficienza e miglior rendimento nell'erogazione della fiamma.

### TRIPLA CORONA



Una tripla corona (3 potenti cerchi di fuoco) è in grado di sviluppare e distribuire in modo omogeneo il calore, riducendo di conseguenza i tempi di cottura. La migliore ripartizione di calore sotto la pentola sfrutta al massimo la potenza e consente una cottura veloce e omogenea.

### ACCENSIONE INTEGRATA SOTTOMANOPOLA

È sufficiente premere contemporaneamente ruotare la manopola affinché vengano attivate sia l'erogazione del gas sia le scintille necessarie per accendere il bruciatore.

### FLAME STEP CONTROL



Flame Step Control permette di poter regolare con precisione 9 livelli di potenza della fiamma, per un controllo ottimale di tutte le fasi di cottura, importante specialmente nelle regolazioni intermedie.

### GRIGLIE IN GHISA



Le griglie, robuste e solide, rivestono un ruolo essenziale nelle fasi della cottura e garantiscono la massima stabilità ad ogni tipo di pentola. L'assenza di spigoli vivi ne facilita la pulizia e grazie alla resistenza del materiale la durata nel tempo è assicurata.

### VALVOLA DI SICUREZZA

In caso di spegnimento accidentale della fiamma, il sistema di sicurezza interrompe l'erogazione del gas, garantendo così la massima sicurezza e praticità d'uso.

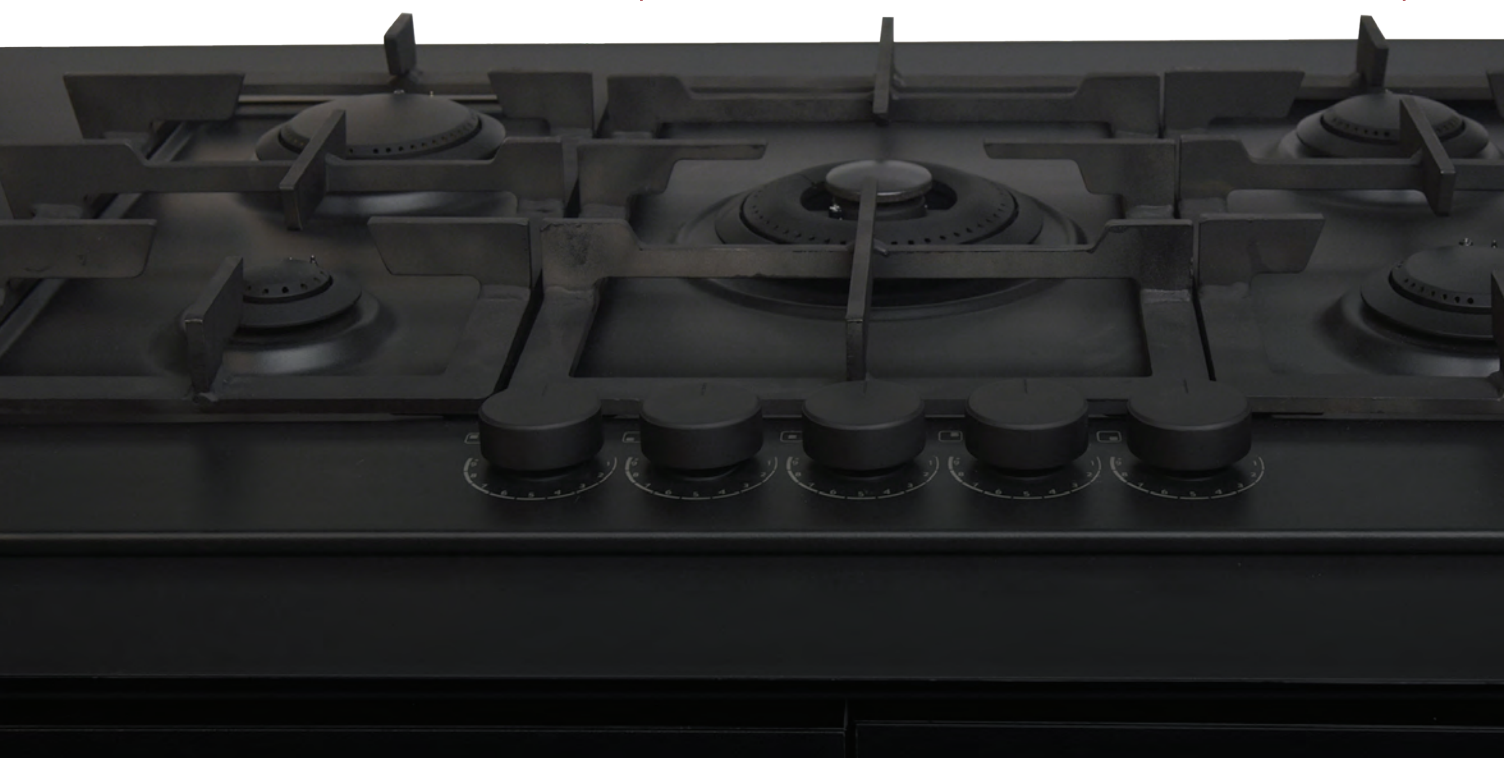

# LEAF 80

Induzione in vitroceramica

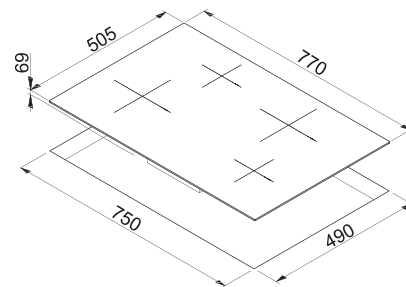

**PIANO COTTURA IN VETROCERAMICA  
ABBINABILE AI COLORI**

## FUNZIONALITÀ



**KERATEK** plus  
CERAMIC NANOTECHNOLOGY CN6

Euro **1278**

● K96 White

PKIL80196

● K86 Black

PKIL80186

## CARATTERISTICHE

Dimensioni (mm)	<b>770 x 505</b>
Foro da Incasso (mm)	<b>750 x 490</b>
Altezza Top (mm)	<b>4</b>
Ingombro Sottopiano (mm)	<b>65</b>

## SPECIFICHE

4 zone cottura a induzione  
2 zone (Ø 210 mm, 1500W) con Booster (2000W),  
2 zone (Ø 145 mm, 1200W) con Booster (1600W)  
Comandi Touch per ogni zona cottura a 9 livelli di potenza  
Programmazione digitale del tempo di cottura (99 min)  
Limitatore di potenza programmabile su 3 livelli  
Funzione cronometro con allarme acustico  
Indicatori di calore residuo e blocco sicurezza bambini  
Potenza massima assorbita: 7200W (o 2800W o 3500W o 6000W)

# LEAF 60

Induzione in vitroceramica

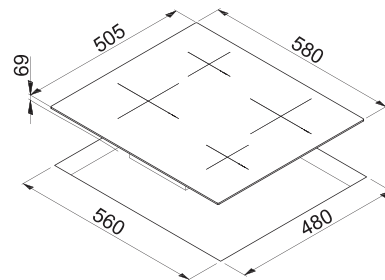

**PIANO COTTURA IN VETROCERAMICA  
ABBINABILE AI COLORI**

## FUNZIONALITÀ



**KERATEK** plus  
CERAMIC NANOTECHNOLOGY CN6

Euro **1092**

● K96 White

PKIL60196

● K86 Black

PKIL60186

## CARATTERISTICHE

Dimensioni (mm)	<b>580 x 505</b>
Foro da Incasso (mm)	<b>560 x 480</b>
Altezza Top (mm)	<b>4</b>
Ingombro Sottopiano (mm)	<b>65</b>

## SPECIFICHE

4 zone cottura a induzione  
2 zone (Ø 210 mm, 1500W) con Booster (2000W),  
2 zone (Ø 145 mm, 1200W) con Booster (1600W)  
Comandi Touch per ogni zona cottura a 9 livelli di potenza  
Programmazione digitale del tempo di cottura (99 min)  
Limitatore di potenza programmabile su 3 livelli  
Funzione cronometro con allarme acustico  
Indicatori di calore residuo e blocco sicurezza bambini  
Potenza massima assorbita: 7200W (o 2800W o 3500W o 6000W)



# LEAF 30

Induzione in vitroceramica

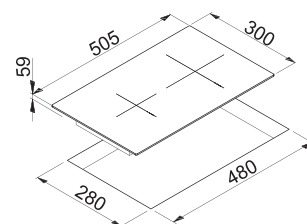

## FUNZIONALITÀ



## PIANO COTTURA IN VETROCERAMICA ABBINABILE AI COLORI

**KERATEK<sup>plus</sup>**  
CERAMIC NANOTECHNOLOGY CMB

Euro **639**

● K86 Black

PKIL30186

## CARATTERISTICHE

Dimensioni (mm)	<b>300 x 505</b>
Foro da Incasso (mm)	<b>280 x 480</b>
Altezza Top (mm)	<b>4</b>
Ingombro Sottopiano (mm)	<b>55</b>

## SPECIFICHE

2 zone cottura a induzione  
1 zone (Ø 210 mm, 1500W) con Booster (2000W),  
1 zone (Ø 145 mm, 1200W) con Booster (1600W)  
Comandi Touch per ogni zona cottura a 9 livelli di potenza  
Programmazione digitale del tempo di cottura (99 min)  
Limitatore di potenza programmabile su 3 livelli  
Funzione cronometro con allarme acustico  
Indicatori di calore residuo e blocco sicurezza bambini  
Potenza massima assorbita: 3600W (o 1600W o 2000W)

### E-BOOST



Tempi di riscaldamento più brevi e fino al 30% in più di potenza grazie alla funzione Boost utilizzabile su ogni singola zona.

### LIMITATORE DI POTENZA



Permette di limitare l'assorbimento elettrico con 3 programmi di configurazione differenti, adattabili a tutte le esigenze casalinghe.

### TOUCH CONTROL PER OGNI ZONA COTTURA



Regola facilmente le impostazioni di temperatura del tuo piano cottura. Ogni zona cottura ha un proprio controllo della potenza, per offrire una chiara visualizzazione e per modificare facilmente le impostazioni della temperatura.

### TIMER



Programmazione digitale del tempo di cottura con allarme acustico configurabile su ogni singola zona del piano cottura a induzione.

### EASY CLEAN



Ogni zona cottura si attiva solo al contatto con la pentola, lasciando il restante piano cottura freddo, questo fa sì che i cibi che fuoriescono non brucino e rimangano facili da pulire.

### BLOCCO DI SICUREZZA BAMBINI



Blocco di Sicurezza che può essere attivato e disattivato in qualunque momento, per bloccare tutte le funzionalità dei comandi touch.

## LEAF GAS ON GLASS 90

Piano a gas da incasso in cristallo temperato

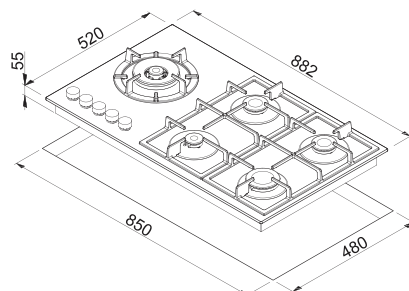

**PIANO COTTURA IN VETRO  
ABBINABILE AI COLORI**

### FUNZIONALITÀ



**KERATEK** plus  
CERAMIC NANOTECHNOLOGY C96

Euro **1018**

● K96 White

PKCQ90296DS

### CARATTERISTICHE

Dimensioni (mm)	<b>882 x 520</b>
Foro da Incasso (mm)	<b>850 x 480</b>
Altezza Top (mm)	<b>8</b>
Ingombro Sottopiano (mm)	<b>47</b>

### SPECIFICHE

5 fuochi a gas, di cui un tripla corona laterale  
1 Tripla Corona 4,5 kW; 1 Rapido 3 kW; 2 Semirapido 1,75 kW; 1 Ausiliario 1 kW  
Accensione integrata nella manopola  
Valvola di sicurezza  
Griglie e coprispartifiamma in ghisa  
Manopole flat silver

## LEAF GAS ON GLASS 70

Piano a gas da incasso in cristallo temperato

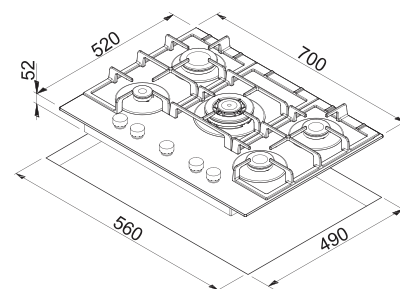

**PIANO COTTURA IN VETRO  
ABBINABILE AI COLORI**

### FUNZIONALITÀ



**KERATEK** plus  
CERAMIC NANOTECHNOLOGY C96

Euro **822**

● K96 White

PKCQ70296CS

● K86 Black

PKCQ70286CS

### CARATTERISTICHE

Dimensioni (mm)	<b>700 x 520</b>
Foro da Incasso (mm)	<b>560 x 490</b>
Altezza Top (mm)	<b>8</b>
Ingombro Sottopiano (mm)	<b>44</b>

### SPECIFICHE

5 fuochi a gas, di cui un tripla corona centrale  
1 Tripla Corona 3,6 kW; 1 Rapido 3 kW; 2 Semirapido 1,75 kW; 1 Ausiliario 1 kW  
Accensione integrata nella manopola  
Valvola di sicurezza  
Griglie e coprispartifiamma in ghisa  
Manopole flat silver

# LEAF GAS ON GLASS 60

Piano a gas da incasso in cristallo temperato

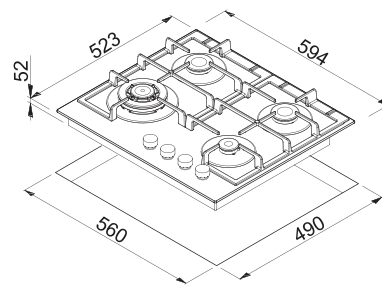

## PIANO COTTURA IN VETRO ABBINABILE AI COLORI

### FUNZIONALITÀ



**KERATEK** plus  
CERAMIC NANOTECHNOLOGY CNB

Euro **698**

● K96 White

PKCQ60296WS

● K86 Black

PKCQ60286WS

### CARATTERISTICHE

Dimensioni (mm)	<b>594 x 523</b>
Foro da Incasso (mm)	<b>560 x 490</b>
Altezza Top (mm)	<b>8</b>
Ingombro Sottopiano (mm)	<b>44</b>

### SPECIFICHE

4 fuochi a gas, di cui un tripla corona laterale  
1 Tripla Corona 3,6 kW; 1 Rapido 3 kW; 2 Semirapido 1,75 kW; 1 Ausiliario 1 kW  
Accensione integrata nella manopola  
Valvola di sicurezza  
Griglie e coprispartifiamma in ghisa  
Manopole flat silver

### TRIPLA CORONA



Una tripla corona (3 potenti cerchi di fuoco) è in grado di sviluppare e distribuire in modo omogeneo il calore, riducendo di conseguenza i tempi di cottura. La migliore ripartizione di calore sotto la pentola sfrutta al massimo la potenza e consente una cottura veloce e omogenea.

### GRIGLIE IN GHISA



Le griglie, robuste e solide, rivestono un ruolo essenziale nelle fasi della cottura e garantiscono la massima stabilità ad ogni tipo di pentola. L'assenza di spigoli vivi ne facilita la pulizia e grazie alla resistenza del materiale la durata nel tempo è assicurata.

### ESTETICA IN VETRO



La tipologia di piani cottura Gas on Glass è una delle più eleganti e funzionali a disposizione: la combinazione dell'estetica in vetro temperato con i potenti bruciatori della gamma è la soluzione di design ideale per associare bellezza e performance.

### ACCENSIONE INTEGRATA SOTTOMANOPOLA



È sufficiente premere e contemporaneamente ruotare la manopola affinché vengano attivate sia l'erogazione del gas sia le scintille necessarie per accendere il bruciatore.

### VALVOLA DI SICUREZZA



In caso di spegnimento accidentale della fiamma, il sistema di sicurezza interrompe l'erogazione del gas, garantendo così la massima sicurezza e praticità d'uso.



# PLANO PLUS 75

NEW

Piano a gas da incasso smaltato



Disponibile da Giugno 2021

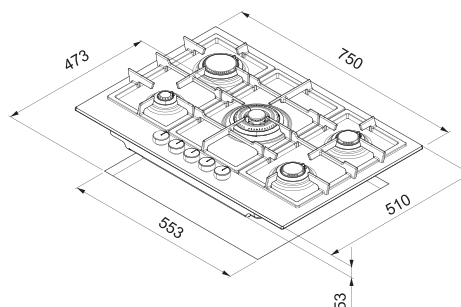

## FUNZIONALITÀ



## CARATTERISTICHE

Dimensioni (mm)	750 x 510
Foro da Incasso (mm)	553 x 473
Altezza Top (mm)	8
Ingombro Sottopiano (mm)	45

## SPECIFICHE

5 fuochi flat a gas, di cui un tripla corona centrale  
1 Tripla Corona 4 kW; 1 Rapido 3 kW; 2 Semirapido 1,75 kW; 1 Ausiliario 1 kW  
Flame step control  
Accensione integrata nella manopola  
Valvola di sicurezza  
Griglie e coprispartifiamma in ghisa  
Manopole flat silver

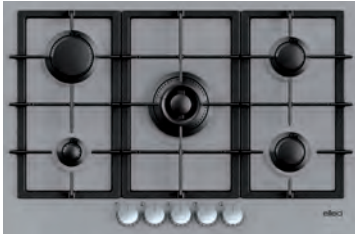

K97 Light Grey



K96 White

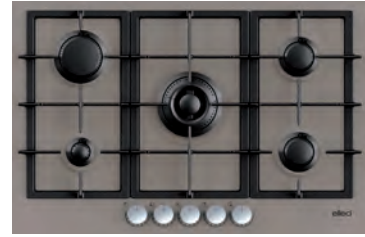

K93 Dove Grey

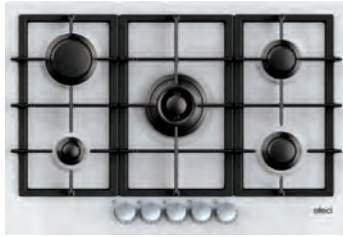

G68 Bianco

Manopola Nera Piano  
Cottura Piano

AMP16301

Euro 15



## PIANO COTTURA SMALTATO ABBINABILE AI COLORI

**KERATEK** Plus  
CERAMIC NANOTECHNOLOGY CNG

Euro 930

- K97 Light Grey PKPP75197CS
- K96 White PKPP75196CS
- K93 Dove Grey PKPP75193CS
- K86 Black PKPP75186CS

**GRANITEK**  
NATURAL GRANITE EFFECT  
MATT

Euro 930

- G68 Bianco PGPP75168CS
- G40 Nero PGPP75140CS

### FLAME STEP CONTROL



Flame Step Control permette di poter regolare con precisione 9 livelli di potenza della fiamma, per un controllo ottimale di tutte le fasi di cottura, importante specialmente nelle regolazioni intermedie.

### FLAT BURNER



Con la loro particolare forma, i Flat Burners permettono di disperdere meno calore laterale, con migliore efficienza e miglior rendimento nell'erogazione della fiamma.

### TRIPLA CORONA



Una tripla corona (3 potenti cerchi di fuoco) è in grado di sviluppare e distribuire in modo omogeneo il calore, riducendo di conseguenza i tempi di cottura. La migliore ripartizione di calore sotto la pentola sfrutta al massimo la potenza e consente una cottura veloce e omogenea.

### GRIGLIE IN GHISA



Le griglie, robuste e solide, rivestono un ruolo essenziale nelle fasi della cottura e garantiscono la massima stabilità ad ogni tipo di pentola. L'assenza di spigoli vivi ne facilita la pulizia e grazie alla resistenza del materiale la durata nel tempo è assicurata.

### ACCENSIONE INTEGRATA SOTTOMANOPOLA



È sufficiente premere e contemporaneamente ruotare la manopola affinché vengano attivate sia l'erogazione del gas sia le scintille necessarie per accendere il bruciatore.

### VALVOLA DI SICUREZZA



In caso di spegnimento accidentale della fiamma, il sistema di sicurezza interrompe l'erogazione del gas, garantendo così la massima sicurezza e praticità d'uso.





## PLANO 75

Piano a gas da incasso smaltato

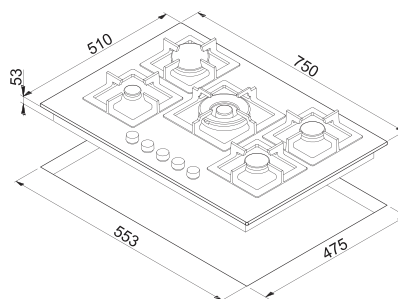

### FUNZIONALITÀ



### CARATTERISTICHE

Dimensioni (mm)	<b>750 x 510</b>
Foro da Incasso (mm)	<b>553 x 475</b>
Altezza Top (mm)	<b>8</b>
Ingombro Sottopiano (mm)	<b>45</b>

### SPECIFICHE

5 fuochi a gas, di cui un tripla corona centrale  
1 Tripla Corona 4 kW; 1 Rapido 3 kW; 2 Semirapido 1,75 kW; 1 Ausiliario 1 kW  
Accensione integrata nella manopola  
Valvola di sicurezza  
Griglie e coprispartifiamma in ghisa  
Manopole flat silver



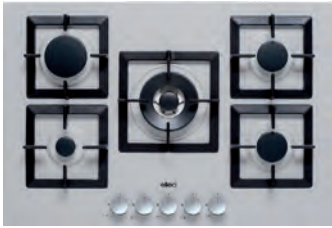

G68 Aluminium



G68 Bianco



G43 Tortora



G40 Nero



G51 Avena



IN Inox

### Manopola Nera Piano Cottura Piano

AMP16301  
Euro **15**



### PIANO COTTURA SMALTATO ABBINABILE AI COLORI

**GRANITEK**  
NATURAL GRANITE EFFECT  
METAL

Euro **616**

- M79 Aluminium PMS75179CS
- M73 Titanium PMS75173CS

**GRANITEK**  
NATURAL GRANITE EFFECT  
MATT

Euro **602**

- G68 Bianco PGSP75168CS
  - G43 Tortora PGSP75143CS
  - G40 Nero PGSP75140CS
- CLASSIC
- G51 Avena PGSP75151CS

**INOX**

Euro **608**

- IN Inox PIAP751INCS

### TRIPLA CORONA



Una tripla corona (3 potenti cerchi di fuoco) è in grado di sviluppare e distribuire in modo omogeneo il calore, riducendo di conseguenza i tempi di cottura. La migliore ripartizione di calore sotto la pentola sfrutta al massimo la potenza e consente una cottura veloce e omogenea.

### GRIGLIE IN GHISA



Le griglie, robuste e solide, rivestono un ruolo essenziale nelle fasi della cottura e garantiscono la massima stabilità ad ogni tipo di pentola. L'assenza di spigoli vivi ne facilita la pulizia e grazie alla resistenza del materiale la durata nel tempo è assicurata.

### ACCENSIONE INTEGRATA SOTTOMANOPIOLA



È sufficiente premere e contemporaneamente ruotare la manopola affinché vengano attivate sia l'erogazione del gas sia le scintille necessarie per accendere il bruciatore.

### VALVOLA DI SICUREZZA



In caso di spegnimento accidentale della fiamma, il sistema di sicurezza interrompe l'erogazione del gas, garantendo così la massima sicurezza e praticità d'uso.

# PLANO 60

Piano a gas da incasso smaltato

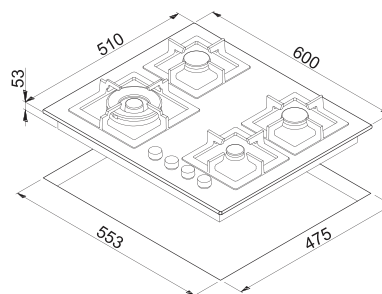

## FUNZIONALITÀ



## CARATTERISTICHE

Dimensioni (mm)	<b>600 x 510</b>
Foro da Incasso (mm)	<b>553 x 475</b>
Altezza Top (mm)	<b>8</b>
Ingombro Sottopiano (mm)	<b>45</b>

## SPECIFICHE

4 fuochi a gas, di cui un tripla corona laterale  
1 Tripla Corona 4 kW; 2 Semirapido 1,75 kW; 1 Ausiliario 1 kW  
Accensione integrata nella manopola  
Valvola di sicurezza  
Griglie e coprispartifiamma in ghisa  
Manopole flat silver

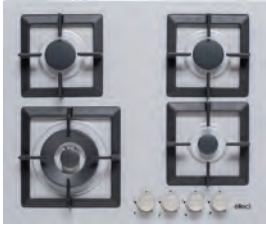

M79 Aluminium

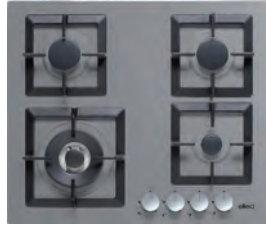

M73 Titanium



G68 Bianco

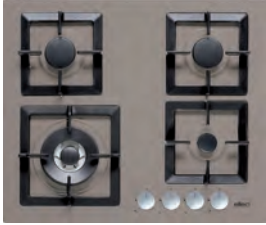

G43 Tortora

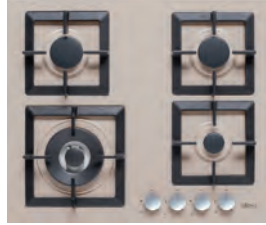

G51 Avena



IN Inox

**Manopola Nera Piano  
Cottura Piano**



AMP16301

Euro **15**

**PIANO COTTURA SMALTATO ABBINABILE AI COLORI**



NATURAL GRANITE EFFECT  
METAL

Euro **550**

- M79 Aluminium PMSP60179WS
- M73 Titanium PMSP60173WS



NATURAL GRANITE EFFECT  
MATT

Euro **536**

- G68 Bianco PGSP60168WS
  - G43 Tortora PGSP60143WS
  - G40 Nero PGSP60140WS
- CLASSIC
- G51 Avena PGSP60151WS

**INOX**

Euro **541**

- IN Inox

PIAP601INWS

**TRIPLA CORONA**



Una tripla corona (3 potenti cerchi di fuoco) è in grado di sviluppare e distribuire in modo omogeneo il calore, riducendo di conseguenza i tempi di cottura. La migliore ripartizione di calore sotto la pentola sfrutta al massimo la potenza e consente una cottura veloce e omogenea.

**GRIGLIE IN GHISA**



Le griglie, robuste e solide, rivestono un ruolo essenziale nelle fasi della cottura e garantiscono la massima stabilità ad ogni tipo di pentola. L'assenza di spigoli vivi ne facilita la pulizia e grazie alla resistenza del materiale la durata nel tempo è assicurata.

**ACCENSIONE INTEGRATA SOTTOMANOPIOLA**



È sufficiente premere e contemporaneamente ruotare la manopola affinché vengano attivate sia l'erogazione del gas sia le scintille necessarie per accendere il bruciatore.

**VALVOLA DI SICUREZZA**



In caso di spegnimento accidentale della fiamma, il sistema di sicurezza interrompe l'erogazione del gas, garantendo così la massima sicurezza e praticità d'uso.



# PLANO 90

Piano a gas da incasso smaltato

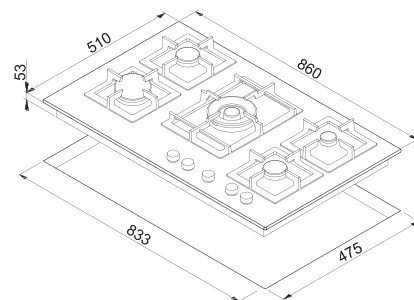

## PIANO COTTURA SMALTATO ABBINABILE AI COLORI

**GRANITEK**  
NATURAL GRANITE EFFECT

Euro 670

MATT

● G68 Bianco

PGSP90168CS

● G40 Nero

PGSP90140CS

## FUNZIONALITÀ



## CARATTERISTICHE

Dimensioni (mm)	<b>860 x 510</b>
Foro da Incasso (mm)	<b>833 x 475</b>
Altezza Top (mm)	<b>8</b>
Ingombro Sottopiano (mm)	<b>45</b>

## SPECIFICHE

5 fuochi a gas, di cui un tripla corona centrale  
1 Tripla Corona 4 kW; 1 Rapido 3 kW; 2 Semirapido 1,75 kW; 1 Ausiliario 1 kW  
Accensione integrata nella manopola  
Valvola di sicurezza  
Griglie e coprispartifiamma in ghisa  
Manopole flat silver

Manopola Nera Piano  
Cottura Piano

AMP16301  
Euro 15



## TRIPLA CORONA



Una tripla corona (3 potenti cerchi di fuoco) è in grado di sviluppare e distribuire in modo omogeneo il calore, riducendo di conseguenza i tempi di cottura. La migliore ripartizione di calore sotto la pentola sfrutta al massimo la potenza e consente una cottura veloce e omogenea.

## GRIGLIE IN GHISA



Le griglie, robuste e solide, rivestono un ruolo essenziale nelle fasi della cottura e garantiscono la massima stabilità ad ogni tipo di pentola. L'assenza di spigoli vivi ne facilita la pulizia e grazie alla resistenza del materiale la durata nel tempo è assicurata.

## ACCENSIONE INTEGRATA SOTTOMANOPIOLA



È sufficiente premere e contemporaneamente ruotare la manopola affinché vengano attivate sia l'erogazione del gas sia le scintille necessarie per accendere il bruciatore.

## VALVOLA DI SICUREZZA



In caso di spegnimento accidentale della fiamma, il sistema di sicurezza interrompe l'erogazione del gas, garantendo così la massima sicurezza e praticità d'uso.

# STYLE 90

Piano a gas da incasso smaltato

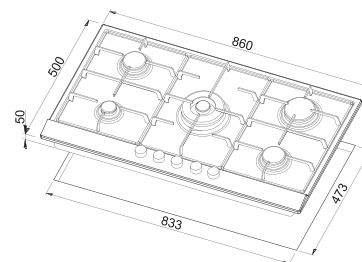

**PIANO COTTURA SMALTATO  
ABBINABILE AI COLORI**

## FUNZIONALITÀ



**GRANITEK**  
NATURAL GRANITE EFFECT

Euro **740**

CLASSIC

G51 Avena

PGSS90251CNG

## CARATTERISTICHE

Dimensioni (mm)	<b>860 x 500</b>
Foro da Incasso (mm)	<b>833 x 473</b>
Altezza Top (mm)	<b>20</b>
Ingombro Sottopiano (mm)	<b>35</b>

## SPECIFICHE

5 fuochi a gas, di cui un tripla corona centrale  
1 Tripla Corona 3,35 kW; 1 Rapido 3 kW; 2 Semirapido 1,75 kW; 1 Ausiliario 1 kW  
Accensione integrata nella manopola  
Valvola di sicurezza  
Manopole flat nere  
Griglie in ghisa

### TRIPLA CORONA



Una tripla corona (3 potenti cerchi di fuoco) è in grado di sviluppare e distribuire in modo omogeneo il calore, riducendo di conseguenza i tempi di cottura. La migliore ripartizione di calore sotto la pentola sfrutta al massimo la potenza e consente una cottura veloce e omogenea.

### GRIGLIE IN GHISA



Le griglie, robuste e solide, rivestono un ruolo essenziale nelle fasi della cottura e garantiscono la massima stabilità ad ogni tipo di pentola. L'assenza di spigoli vivi ne facilita la pulizia e grazie alla resistenza del materiale la durata nel tempo è assicurata.

Manopola Ottonata  
Piano Cottura

AMP40302  
Euro **25**



Manopola Silver Piano  
Cottura Style

AMP50300  
Euro **15**



Manopola Nera Piano  
Cottura Style

AMP50301  
Euro **15**







## STYLE 75

NEW

Piano a gas da incasso smaltato

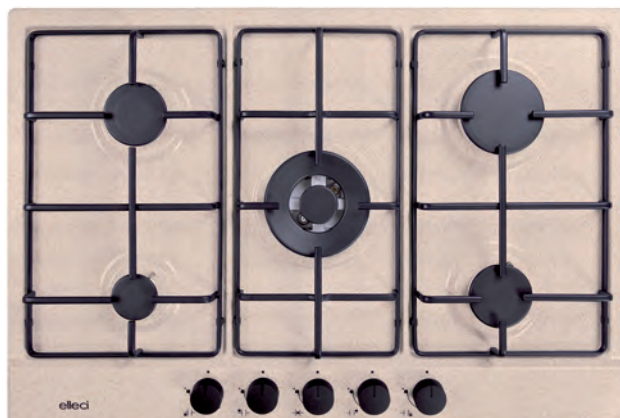

Disponibile da Giugno 2021

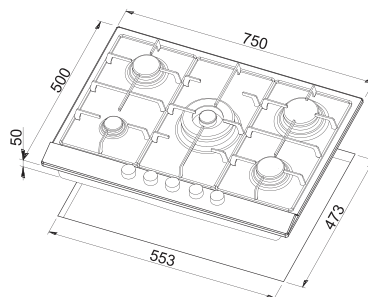

### FUNZIONALITÀ



### CARATTERISTICHE

Dimensioni (mm)	<b>750 x 500</b>
Foro da Incasso (mm)	<b>553 x 473</b>
Altezza Top (mm)	<b>20</b>
Ingombro Sottopiano (mm)	<b>35</b>

### SPECIFICHE

5 fuochi a gas, di cui un tripla corona centrale  
1 Tripla Corona 3,35 kW; 1 Rapido 3 kW; 2 Semirapido 1,75 kW; 1 Ausiliario 1 kW  
Accensione integrata nella manopola  
Valvola di sicurezza  
Manopole flat nere  
Griglie lamellari e piattelli opachi Nero Matt





G68 Bianco



G48 Cemento



G59 Antracite

**Manopola Ottonata  
Piano Cottura**



AMP40302  
Euro 25

**Manopola Silver Piano  
Cottura Style**



AMP50300  
Euro 15

**Manopola Nera Piano  
Cottura Style**



AMP50301  
Euro 15

**Griglie In Ghisa Style 75**



AKG03303  
Euro 190

**PIANO COTTURA SMALTATO ABBINABILE AI COLORI**



Euro 560

MATT

- G68 Bianco PGSS75368CB
- G48 Cemento PGSS75348CB

**CLASSIC**

- G59 Antracite PGSS75359CB
- G51 Avena PGSS75351CB

**TRIPLA CORONA**



Una tripla corona (3 potenti cerchi di fuoco) è in grado di sviluppare e distribuire in modo omogeneo il calore, riducendo di conseguenza i tempi di cottura. La migliore ripartizione di calore sotto la pentola sfrutta al massimo la potenza e consente una cottura veloce e omogenea.

**GRIGLIE LAMELLARI E PIATTPELLI OPACHI**



Le griglie lamellari e i piattPELLI opachi black matt conferiscono un tocco ulteriore di matericità al piano di cottura Style, rendendolo la scelta ottimale per arredare gli ambienti cucina classici.

**ACCENSIONE INTEGRATA SOTTOMANOPOLA**



È sufficiente premere e contemporaneamente ruotare la manopola affinché vengano attivate sia l'erogazione del gas sia le scintille necessarie per accendere il bruciatore.

**VALVOLA DI SICUREZZA**



In caso di spegnimento accidentale della fiamma, il sistema di sicurezza interrompe l'erogazione del gas, garantendo così la massima sicurezza e praticità d'uso.

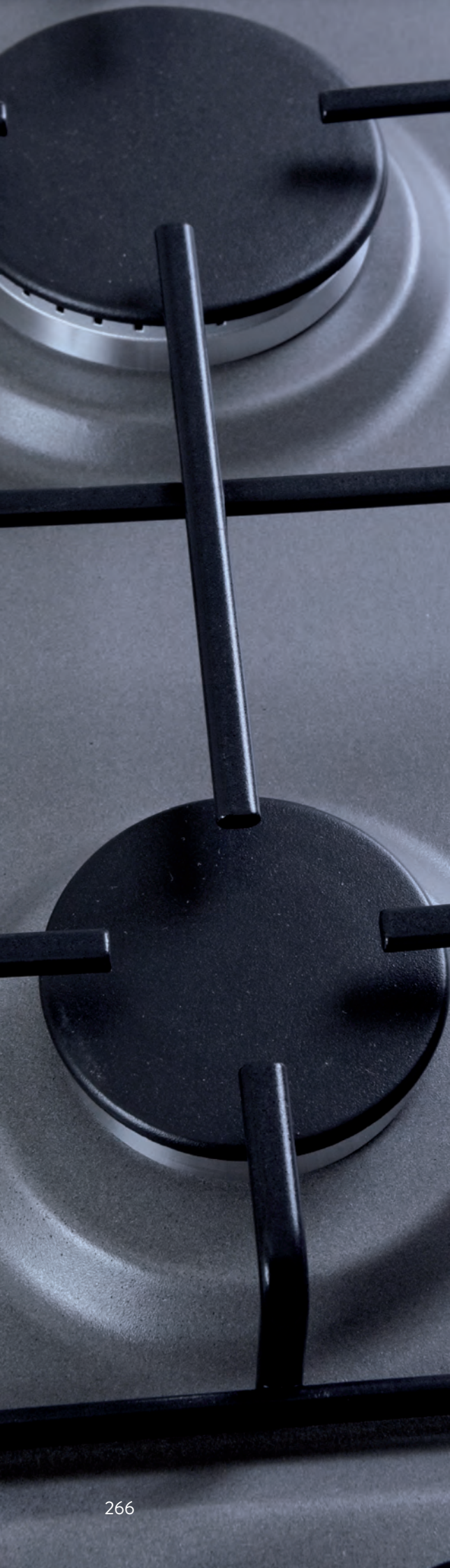

## STYLE 60

NEW

Piano a gas da incasso smaltato



Disponibile da Giugno 2021

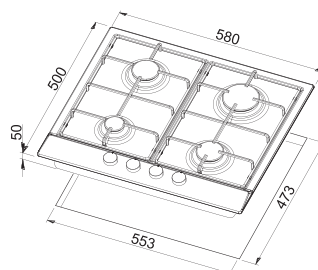

### FUNZIONALITÀ



### CARATTERISTICHE

Dimensioni (mm)	<b>580 x 500</b>
Foro da Incasso (mm)	<b>553 x 473</b>
Altezza Top (mm)	<b>20</b>
Ingombro Sottopiano (mm)	<b>35</b>

### SPECIFICHE

4 fuochi a gas  
1 Rapido 3 kW; 2 Semirapido 1,75 kW; 1 Ausiliario 1 kW  
Accensione integrata nella manopola  
Valvola di sicurezza  
Manopole flat nere  
Griglie lamellari e piattelli opachi Nero Matt



G68 Bianco



G59 Antracite



G51 Avena

**Manopola Ottonata  
Piano Cottura**



AMP40302  
Euro **25**

**Manopola Silver Piano  
Cottura Style**



AMP50300  
Euro **15**

**Manopola Nera Piano  
Cottura Style**



AMP50301  
Euro **15**

**Griglie In Ghisa Style 60**



AKG01304  
Euro **130**

**PIANO COTTURA SMALTATO ABBINABILE AI COLORI**



Euro **438**

MATT

- G68 Bianco PGSS60268WB
- G48 Cemento PGSS60248WB

CLASSIC

- G59 Antracite PGSS60259WB
- G51 Avena PGSS60251WB

**GRIGLIE LAMELLARI E PIATTPELLI OPACHI**



Le griglie lamellari e i piattPELLI opachi black matt conferiscono un tocco ulteriore di matericit  al piano di cottura Style, rendendolo la scelta ottimale per arredare gli ambienti cucina classici.

**ACCENSIONE INTEGRATA SOTTOMANOPIOLA**



È sufficiente premere e contemporaneamente ruotare la manopola affinché vengano attivate sia l'erogazione del gas sia le scintille necessarie per accendere il bruciatore.

**VALVOLA DI SICUREZZA**



In caso di spegnimento accidentale della fiamma, il sistema di sicurezza interrompe l'erogazione del gas, garantendo cos  la massima sicurezza e praticit  d'uso.



# LEAF VERTICAL

Cappa aspirante verticale in vetro satinato e lucido



**NEW**

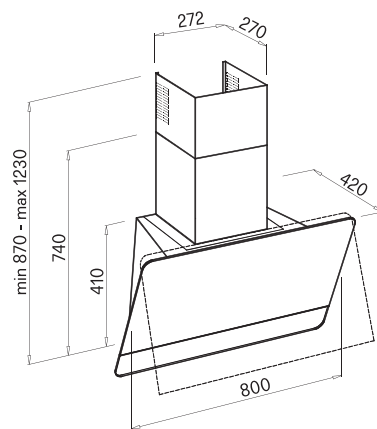

## CARATTERISTICHE

Dimensioni (mm)	<b>800 x 1230 x 420</b>
Comandi	<b>Touch control sul vetro</b>
Numero Velocità	<b>4</b>
Portata Massima	<b>750 m<sup>3</sup>/h</b>
Pressione	<b>565 Pa</b>
Rumorosità Massima	<b>65 dbA</b>
Bocca Uscita	<b>150</b>

## ESTETICA CAPPa IN VETRO ABBINABILE AI COLORI

**KERATEK** plus  
CERAMIC NANOTECHNOLOGY CNB

Euro **1391**

● K96 White

KKQ80096VST

● K86 Black

KKQ80086VST

### Accessorio

Filtro carbone

Codice

AFC01302

Euro

**53**

# LEAF BOX

Cappa aspirante in acciaio Inox e vetro frontale



**NEW**

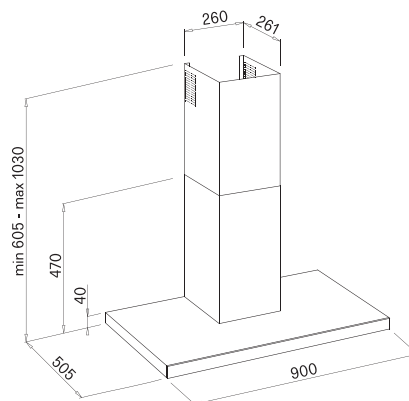

## CARATTERISTICHE

Dimensioni (mm)	<b>900 x 1030 x 505</b>
Comandi	<b>Touch control</b>
Numero Velocità	<b>3+1</b>
Portata Massima	<b>680 m<sup>3</sup>/h</b>
Pressione	<b>436 Pa</b>
Rumorosità Massima	<b>69 dbA</b>
Bocca Uscita	<b>150</b>

## ESTETICA CAPPa IN ACCIAIO INOX E VETRO ABBINABILE AI COLORI

**KERATEK** plus  
CERAMIC NANOTECHNOLOGY CNB

Euro **1071**

● K96 White

KKL90096VST

● K86 Black

KKL90086VST

### Accessori

Filtro carbone

Codice

AFC01303

Euro

**98**

Kit deviatore aria

ADA01300

**27**



NEW

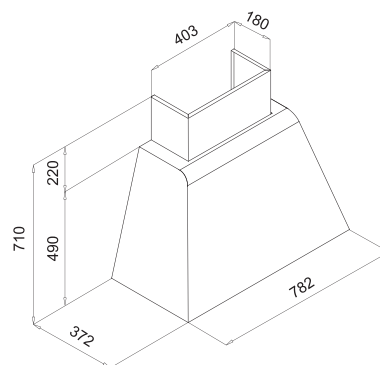

## CARATTERISTICHE

Dimensioni (mm)	782 x 372 x 490
Comandi	Slider
Numero Velocità	3
Portata Massima	368 m <sup>3</sup> /h
Pressione	218 Pa
Rumorosità Massima	58 dbA
Bocca Uscita	120
Classe Energetica	D

## ESTETICA CAPPA SMALTATA ABBINABILE AI COLORI

**GRANITEK**  
NATURAL GRANITE EFFECT

Euro 754

MATT



G40 Nero

KGPB8040M

## Accessorio

Filtro carbone

Codice Euro

AFC01304 82



NEW

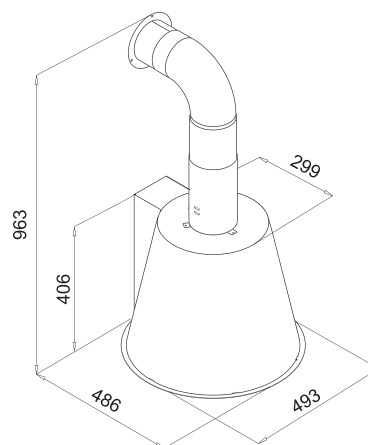

## CARATTERISTICHE

Dimensioni (mm)	ø 493 x h 406
Comandi	Slider
Numero Velocità	3
Portata Massima	520 m <sup>3</sup> /h
Pressione	151 Pa
Rumorosità Massima	65 dbA
Bocca Uscita	120
Classe Energetica	D

## ESTETICA CAPPA SMALTATA ABBINABILE AI COLORI

**GRANITEK**  
NATURAL GRANITE EFFECT

Euro 644

MATT



G40 Nero

KGPURO40M

## Accessorio

Filtro carbone

Codice Euro

AFC01305 82

COLLEZIONE

# DISSIPATORI

Il dissipatore di rifiuti alimentari (DRA) è un moderno elettrodomestico essenziale che ci libera dai rifiuti organici e rende la nostra vita più facile in cucina. È sufficiente premere un solo pulsante e il cibo verrà tritato e smaltito. Facile da installare, non ingombrante, silenzioso e sicuro. I rifiuti vengono ridotti in piccole particelle e scaricati nel sistema fognario attraverso l'acqua.

#### Vantaggi:

Niente più cattivi odori  
Risparmio economico  
Riduzione dei rifiuti da smaltire  
Ambiente più sano  
Riduzione CO2

#### Più silenzioso del 40%

Tutti i dissipatori Elleci sono progettati per ridurre al minimo il coefficiente di vibrazione e la rumorosità. Con la combinazione di questi due fattori i dissipatori Elleci sono più silenziosi del 40% rispetto ai prodotti tradizionali.

#### Grande camera di dissipazione

Una cavità volumetrica maggiore comporta un minor rischio di intasamento e una migliore triturazione.



Attraverso questo elettrodomestico è possibile smaltire rifiuti organici quali: frutta, verdura, lische di pesce, gusci, ossa di pollo e molti altri.

Non è possibile smaltire cibi fibrosi quali: carciofi, finocchi, ananas, ecc.

## STAINLESS STEEL HIGH QUALITY PARTS



1 Installazione facile e veloce

5 Innovativo Design Italiano

2 Protezione Antibatterica e Sistema Antiodore

6 Sistema Reset di Sicurezza

3 Componenti in acciaio inox

7 Interruttore pneumatico ad aria incluso

4 Motore a corrente diretta ad elevata potenza

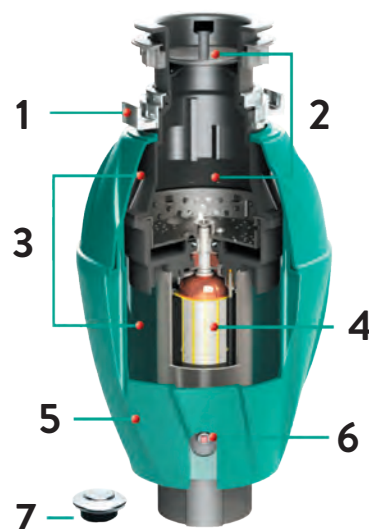



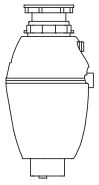

**MODELLO 1000 TOP**  
PAG. 272

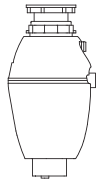

**MODELLO 750 TOP**  
PAG. 272

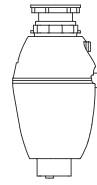

**MODELLO 750**  
PAG. 272

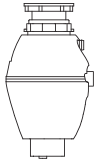

**MODELLO 500 TOP**  
PAG. 273

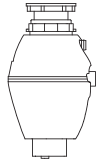

**MODELLO 500**  
PAG. 273



## MODELLO 1000 TOP

Deluxe 1 Hp

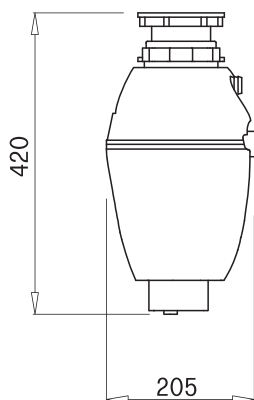

4 ANNI - YEARS WARRANTY  
GARANTITO

### CARATTERISTICHE

Dimensioni (mm) 205 x 420

4.8  
KG

Modello	Prezzo Euro
<b>TDH01000</b>	<b>458</b>
Potenza Watt:	750
Tensione VAC:	220/240
Assorbimento (Ampere):	3,4
r/min.:	2800
Peso (kg) VAC:	4,8
Capacità:	1070 ml.

## MODELLO 750 TOP

Deluxe 0.75 Hp

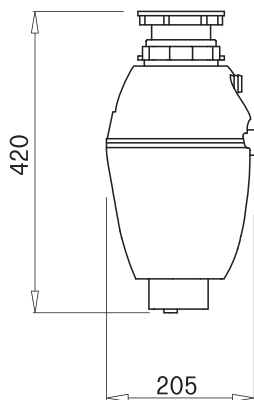

4 ANNI - YEARS WARRANTY  
GARANTITO

### CARATTERISTICHE

Dimensioni (mm) 205 x 420

4.7  
KG

Modello	Prezzo Euro
<b>TDH00750</b>	<b>408</b>
Potenza Watt:	550
Tensione VAC:	220/240
Assorbimento (Ampere):	2,5
r/min.:	2800
Peso (kg) VAC:	4,7
Capacità:	1070 ml.

## MODELLO 750

0.75 Hp

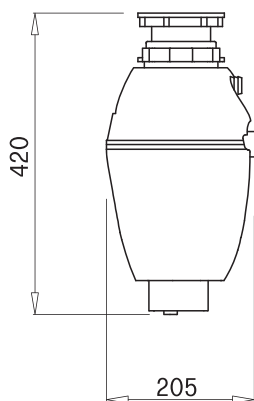

2 ANNI - YEARS WARRANTY  
GARANTITO

### CARATTERISTICHE

Dimensioni (mm) 205 x 420

4.5  
KG

Modello	Prezzo Euro
<b>TDM00750</b>	<b>378</b>
Potenza Watt:	550
Tensione VAC:	220/240
Assorbimento (Ampere):	2,5
r/min.:	2800
Peso (kg) VAC:	4,5
Capacità:	860 ml.

## MODELLO 500 TOP

Deluxe 0.5 Hp

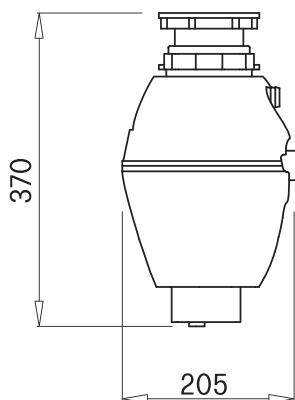

**4 ANNI - YEARS WARRANTY GARANTITO**

### CARATTERISTICHE

Dimensioni (mm) 205 x 370

**4.5**  
KG

Modello **TDH00500** Prezzo Euro **332**

Potenza Watt: 375

Tensione VAC: 220/240

Assorbimento (Ampere): 1,7

r/min.: 2800

Peso (kg) VAC: 4,5

Capacità: 1070 ml.

## MODELLO 500

0.5 Hp

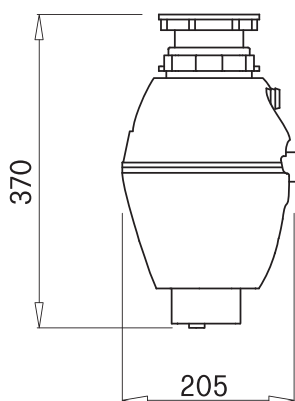

**2 ANNI - YEARS WARRANTY GARANTITO**

### CARATTERISTICHE

Dimensioni (mm) 205 x 370

**4.3**  
KG

Modello **TDM00500** Prezzo Euro **312**

Potenza Watt: 375

Tensione VAC: 220/240

Assorbimento (Ampere): 1,7

r/min.: 2800

Peso (kg) VAC: 4,3

Capacità: 860 ml.

### Accessori inclusi



Spingitore rifiuti.



Gomma paraspruzzi removibile e lavabile (anche in lavastoviglie).



Tappo standard.



Gomito di fissaggio.



**Air switch: attuatore pneumatico (pulsante di accensione ad aria, non elettronico).**

### Accessori consigliati



Flangia dissipatore per piletta quadrata

ATQ01300  
€ 35



Radiocomando accensione

ARP01300  
€ 75

## ESPOSITORE



Consigliamo di esporre i seguenti articoli: TDM00750 o TDH00750.

Nella parte superiore consigliamo di allocare il leaflet Green Power (codice: LEA1007).

Modello **ESPDISSIT** Prezzo Euro **118**

Espositore da banco per nr. 1 dissipatore Green Power. Espositore realizzato in plexiglass bicolour (trasparente/verde).





## ELLECI SEMPRE PIÙ VICINO A TE

Elceci ha cura dei propri clienti e lo dimostra utilizzando i materiali più innovativi e le tecnologie più all'avanguardia per offrire il massimo della qualità. Qualità certificata da precise norme di produzione, conformi a ISO 45001:2018, ISO 14001:2015 e ISO 9001:2015.

Elceci ti assicura una garanzia della durata variabile, a seconda della categoria del prodotto che hai scelto. Tali durate sono indicate nei rispettivi manuali di utilizzo/installazione.

PRODOTTO	GARANZIA
LAVELLI IN COMPOSITO - KERATEK PLUS	20 ANNI
LAVELLI IN COMPOSITO - GRANITEK	10 ANNI
LAVELLI INOX / MISCELATORI / ELETTRODOMESTICI / ACCESSORI	2 ANNI
DISSIPATORI	4 ANNI / 2 ANNI a seconda del modello

## UN NUOVO NUMERO VERDE A TUA DISPOSIZIONE, UN NUOVO SERVIZIO DI ASSISTENZA PRE E POST-VENDITA

Elceci ha potenziato il suo Customer Care, un vero e proprio team di professionisti pronto ad offrirti un servizio ancora più tempestivo ed efficiente. Un solo numero verde per gestire tutte le richieste, **attivo dal lunedì al venerdì dalle 8.30 alle 13.00 e dalle 14.00 alle 17.30**, e raggiungibile sia da numero fisso sia da smartphone.



Il Customer Care Elceci sarà al tuo fianco in modo rapido e affidabile, provvedendo a trovare la soluzione più idonea per garantire la tua piena soddisfazione.

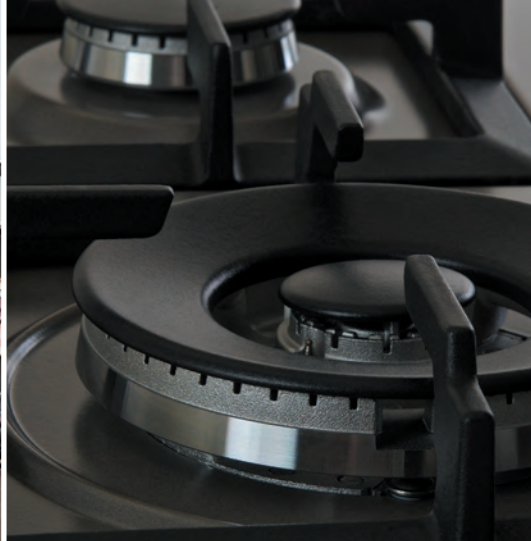

## LA TUA SODDISFAZIONE È IL NOSTRO OBIETTIVO

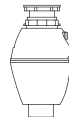
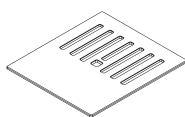
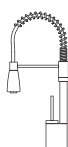
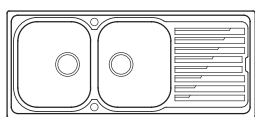
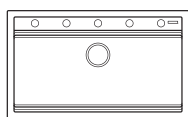

In caso di assistenza tecnica su lavelli in composito, lavelli inox, miscelatori, accessori e dissipatori, e dopo l'inserimento dei necessari dati e documentazioni, il Customer Care elaborerà la pratica, fornendoti riscontro entro le 48 ore successive.

Se la pratica rientra in garanzia, essa verrà conclusa nell'arco dei 7 giorni successivi alla data dell'invio della mail con la comunicazione dell'esito della pratica stessa.

## LA DISPONIBILITÀ, IL SUPPORTO E L'ASSISTENZA DI PERSONALE QUALIFICATO

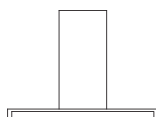
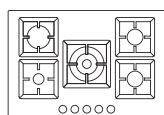
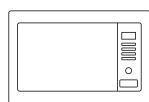

In caso di segnalazioni riguardanti gli elettrodomestici (piani cottura, forni e cappe), esse verranno gestite tramite circa 350 centri di assistenza tecnica (CAT) da noi appositamente incaricati. Anche in questo caso, dopo aver fornito i necessari dati e documentazioni, il Customer Care Elleci prenderà contatto con te entro le 48 ore successive alla segnalazione per definire e concordare le successive tempistiche di uscita e/o di risoluzione pratica.



*Si raccomanda vivamente di conservare la ricevuta/fattura comprovante l'acquisto, senza la quale non potremo procedere ad alcun tipo di intervento in garanzia.*



Per maggiori informazioni, puoi consultare il sito [www.elleci.com](http://www.elleci.com).

TABELLA

# COMPARATIVA

PRINCIPALI MARCHI DI ELETTRODOMESTICI E TOP CUCINA



SMEG HOTPOINT INDESIT ELECTROLUX WHIRLPOOL BOSCH CANDY SIEMENS FENIX



K99 Dark Grey									
K97 Light Grey									grigio antrim
K96 White	vetro bianco	bianco	bianco	vetro bianco	bianco	bianco	vetro bianco	bianco	bianco kos
K95 Champagne									
K93 Dove Grey									grigio londra
K86 Black	vetro nero	nero	nero	vetro nero	nero	nero	vetro nero	nero	nero ingo



M79 Aluminium	alluminio	-	-	-	-	-	-	-	-
M78 Espresso	-	caffè	-	-	-	-	-	-	-
M73 Titanium	titanio	-	-	-	-	-	-	-	-
M70 Ghisa									



G68 Bianco	bianco	bianco	bianco	bianco	bianco	bianco	bianco	-	-
G48 Cemento									
G43 Tortora	-	-	tortora	-	-	-	-	-	-
G40 Nero	nero	-	nero	nero	nero	nero	vetro nero	-	-
G62 Bianco antico	panna	bianco antico	-	bianco antico	jasmine	-	-	-	-
G59 Antracite	antracite	antracite	antracite	nero ghisa	antracite	-	ghisa	-	-
G55 Grigio pietra									
G54 Nero pietra									
G52 Bianco pietra	-	granito bianco	-	-	-	-	-	-	-
G51 Avena	avena	avena	avena	sabbia	avena	-	avena	-	-











REALIZZATO DA ELLECI S.P.A.

Art direction

Copywriting

in collaborazione con

MANDARINO ADV S.R.L.

Design and Communication

ARCHÈ AGENCY S.R.L.

Scenic Art Direction

Photorealistic 3D

ORILIA ADV

Fotografie e post-produzione immagini

BIEFFE SRL

Stampa

Stampato su carta certificata FSC.

IL CATALOGO È PROPRIETÀ DI ELLECI S.P.A. TUTTI I DIRITTI SONO RISERVATI.

Sono tassativamente vietate le riproduzioni del presente catalogo, anche parziali, per fini commerciali senza specifica autorizzazione da parte di Elleci.

Elleci S.p.A. declina ogni responsabilità per possibili errori o inesattezze contenute nel catalogo, oltre a precisare che le immagini inserite e i dati forniti sono puramente indicativi.

LA STAMPA TIPOGRAFICA NON SEMPRE RIPRODUCE FEDELMENTE LE TINTE ED I MATERIALI ORIGINALI.

La riproduzione dei colori è PERTANTO da ritenersi puramente indicativa.

ELLECI S.P.A. SI RISERVA DI APPORTARE IN QUALSIASI MOMENTO E SENZA PREAVVISO MODIFICHE RITENUTE UTILI AL MIGLIORAMENTO DEI PROPRI PRODOTTI PRESENTI SU QUESTO CATALOGO.

I prezzi riportati nel presente Catalogo Listino sono al netto di IVA, trasporto ed eventuale ECO-Contributo RAEE.

# LE COLORAZIONI DEI MATERIALI

## VANTAGGI KERATEK PLUS E GRANITEK



**KERATEK<sup>®</sup> Plus**  
CERAMIC NANOTECHNOLOGY CN6



SUPERFICIE  
**ULTRACOMPATTA**



**20 ANNI-YEARS  
WARRANTY  
GARANTITO**

**K99**



DARK GREY

**K97**



LIGHT GREY

**K96**



WHITE

**K95**



CHAMPAGNE

**K93**



DOVE GREY

**K86**



BLACK

**GRANITEK<sup>®</sup>**  
NATURAL GRANITE EFFECT



SUPERFICIE  
**ULTRAMATERICA**

**10 ANNI-YEARS  
WARRANTY  
GARANTITO**

METAL

**M79**



ALUMINIUM

**M78**



ESPRESSO

**M73**



TITANIUM

**M70**



GHISA

MATT

**G68**



BIANCO

**G48**



CEMENTO

**G43**



TORTORA

**G40**



NERO

CLASSIC

**G62**



BIANCO  
ANTICO

**G59**



ANTRACITE

**G55**



GRIGIO PIETRA

**G54**



NERO PIETRA

**G52**



BIANCO  
PIETRA

**G51**



AVENA

LISTI2021



*italian origin*

ELLECI S.p.A. Strada Longitudinale A 1258,  
Z.I. Mazzocchio 04014 Pontinia (LT) - Italy  
Tel. +39 0773 84 00 36  
Fax +39 0773 85 35 17  
[www.elleci.com](http://www.elleci.com) - email: [elleci@elleci.it](mailto:elleci@elleci.it)

